



# 6,95" TFT/LCD 2 DIN NAVIGATION DVD RECEIVER

ITALIANO

ENGLISH

FRANÇAIS

DEUTSCH

ESPAÑOL

*MANUALE ISTRUZIONI • INSTRUCTIONS MANUAL  
NOTICE DE MONTAGE ET D'EMPLOI • GEBRAUCHSANWEISUNGEN  
MANUAL DE INSTRUCCIONES*

## **VM 033**

## INDICE - INDEX

### IT-GB

Connessioni / Connections .....	3-4
Funzioni / Functions .....	5
Funzioni Telecomando / Remote control functions .....	6
Menù / Menu .....	7
Impostazioni di sistema / System setup .....	8-11
Impostazioni GPS / GPS setup .....	10
Radio / Radio .....	12
Equalizzatore / Equalizer .....	12
Riproduzione / Playback DVD-CD-USB-SD CARD .....	13-14
Impostazioni Bluetooth / Bluetooth setup .....	15-16
IPOD .....	16

### FR-D

Connexions / Kabel-Verbindungen .....	17-18
Fonctions / Funktionen .....	19
Fonctions télécommande / Fernbedienungs-tasten .....	20
Menu / Menü .....	21
Reglages De Systeme / System-Einstellungen .....	22-25
Reglages GPS / GPS-Einstellungen .....	26
Radio / Radio .....	27
Egaliseur / Equalizer .....	27
Reproduction / Wiedergabe DVD-CD-USB-SD CARD .....	28-29
Reglages bluetooth / Bluetooth-Einstellungen .....	30-31
IPOD .....	31

### E

Conexiones .....	31-32
Funciones .....	33
Funciones mando a distancia .....	34
Menu .....	35
Adjuste del sistema .....	36-39

Configuraciones GPS .....	38
Radio .....	40
Equalizador .....	40
Reproduccion DVD-CD-USB-SD CARD .....	41-42
Ajustes bluetooth .....	43-44
IPOD .....	44
Caracteristicas tecnicas .....	45

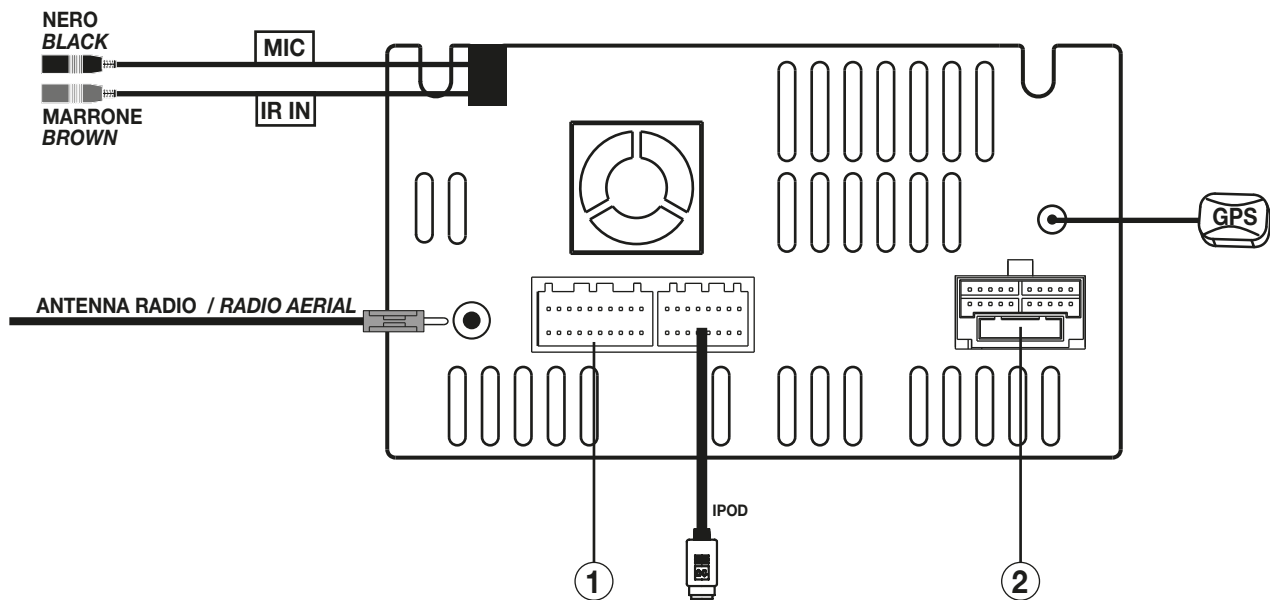

1 USCITE-INGRESSI AUDIO/VIDEO / OUTPUT-INPUT AUDIO/VIDEO

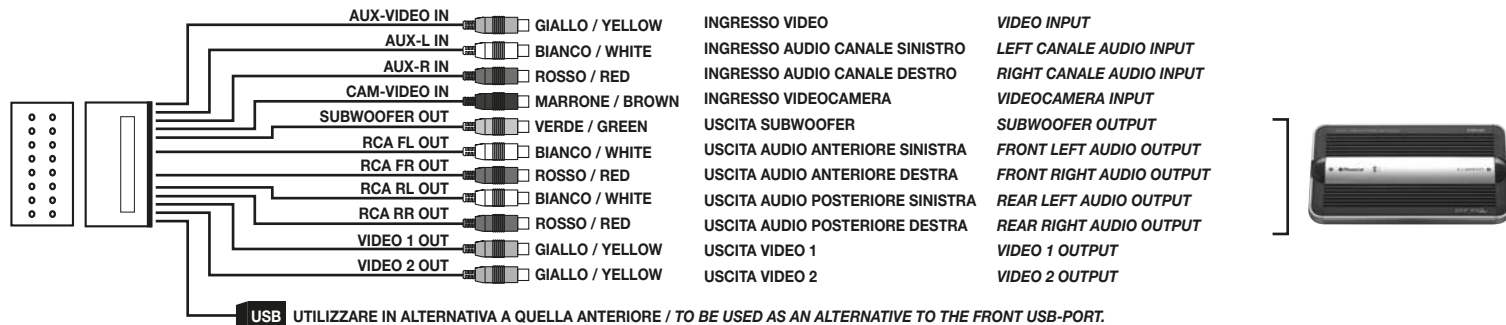

2 USCITE ALTOPARLANTI - COMANDI AL VOLANTE - SERVIZI / SPEAKERS OUTPUT - STEERING WHEEL COMMAND - SERVICES



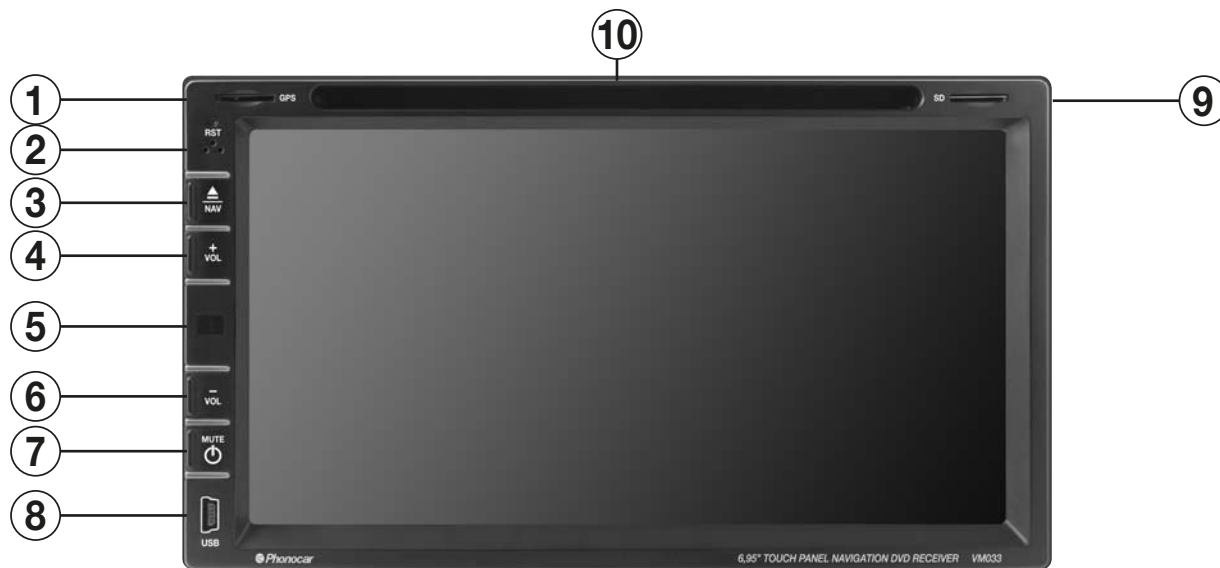

1. Porta micro SD **per navigazione**
2. Tasto reset
3. Navigazione - Espulsione disco\*
4. Incrementa volume
5. Sensore IR
6. Decrementa volume
7. Accensione - Mute
8. Porta Mini-USB  
Da utilizzare in alternativa a quella posteriore
9. Slot SD card
10. Feritoia inserimento disco

1. *Micro-SD-slot **for navigation***
2. *Reset key*
3. *Disk eject*
4. *Increase Volume*
5. *IR-Sensor*
6. *Reduce Volume*
7. *Power - Mute*
8. *Mini-USB-port to be used as an alternative to the rear USB-port.*
9. *SD card slot*
10. *Opening for CD-introduction*

\*Tenere premuto 2 secondi per avviare la navigazione.    \*Keep pressed for 2 seconds so that Navigation will start.

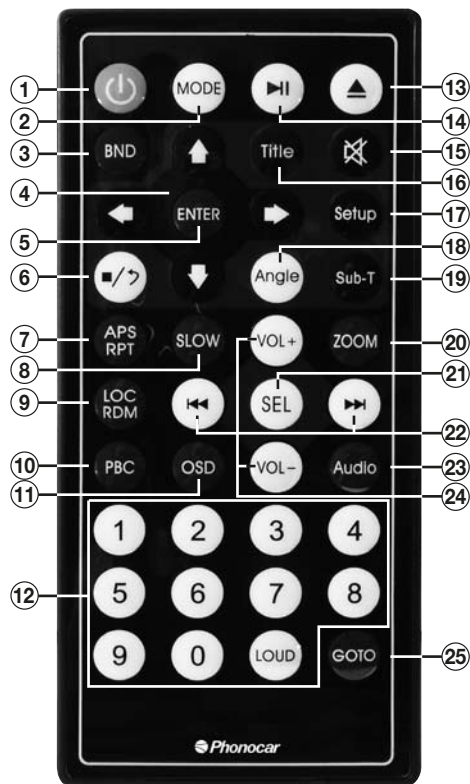

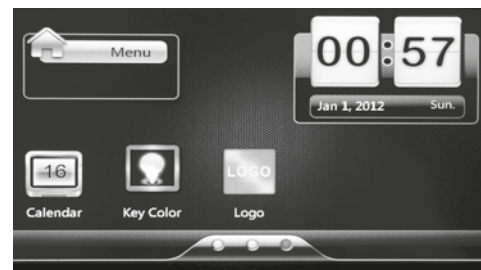

- |  |  |
|--|--|
| <ol style="list-style-type: none"> <li>1. Accensione/spengimento.</li> <li>2. Cambia sorgente.</li> <li>3. Banda radio.</li> <li>4. Frecce direzionali per muoversi su menù.</li> <li>5. Conferma selezione.</li> <li>6. Interrompe/riavvia riproduzione.</li> <li>7. Ripetizione traccia/capitolo/disco.</li> <li>8. Riproduzione rallentata.</li> <li>9. Ricezione stazioni locali radio.<br/>Riproduzione casuale CD/USB/Micro SD Card.</li> <li>10. In modalità DVD-VCD compaiono su schermo le tracce del disco ed possibile selezionarle direttamente. <b>Funzione disponibile solo su supporti DVD con PBC.</b></li> <li>11. Mostra le informazioni di riproduzione sullo schermo.</li> <li>12. Tastierino numerico.</li> <li>13. Espulsione disco.</li> <li>14. Pausa/avvia riproduzione.</li> <li>15. Silenzia audio.</li> <li>16. Menù principale DVD.</li> <li>17. Menù impostazioni.</li> <li>18. Cambia angolo visione DVD.</li> <li>19. Sottotitoli.</li> <li>20. Ingrandisce/rimpicciolisce immagine.</li> <li>21. Regolazione toni/bilanciamento audio/EQ.</li> <li>22. Traccia/stazione radio precedente/successiva.</li> <li>23. Audio DVD (lingua).</li> <li>24. Regolazione volume.</li> <li>25. Avvia riproduzione dal punto desiderato.</li> </ol> | <ol style="list-style-type: none"> <li>1. Activation/Deactivation.</li> <li>2. Select Source.</li> <li>3. Radio-Band.</li> <li>4. Direction-Keys moving within Menu.</li> <li>5. Confirm selection.</li> <li>6. Interrupt/Resume Reproduction.</li> <li>7. Repeat Track/Chapter/CD.</li> <li>8. Slow-motion</li> <li>9. Reception of Local Radio-Stations/Random Reproduction of CD/USB/Micro-SD</li> <li>10. In DVD-VCD-mode, the CD-Tracks will appear on the screen and can directly be selected. <b>Function available only on DVDs with PBC.</b></li> <li>11. Reproduction-information shown on the screen.</li> <li>12. Number-keys.</li> <li>13. Disk eject.</li> <li>14. Pause/Start reproduction.</li> <li>15. Mute.</li> <li>16. DVD Main Menu.</li> <li>17. Settings Menu.</li> <li>18. Select DVD watching-angle.</li> <li>19. Subtitles.</li> <li>20. Enlarge/Reduce Picture.</li> <li>21. Setting Tone/Balance of Audio/EQ.</li> <li>22. Track/Radio-Station before/after.</li> <li>23. DVD-Audio (language).</li> <li>24. Setting Volume.</li> <li>25. Start Reproduction from requested position.</li> </ol> |
|--|--|



Il dispositivo dopo l'accensione entra automaticamente nella funzione radio. Premere  per entrare nel menù principale. Premere i tasti ● ● ● per girare pagina del menù da destra a sinistra o effettuare lo scorrimento manuale.

Premere l'icona  Settings per entrare nei menù delle impostazioni di sistema.

*After the switch-on, the unit will automatically start with the radio-mode. Press  to enter the Main Menu. Press the keys ● ● ● to turn the Menu-pages, from right to left. Or carry out manual scrolling.*

*Press the Setting-Icon , to enter the System-Setting-Menus.*

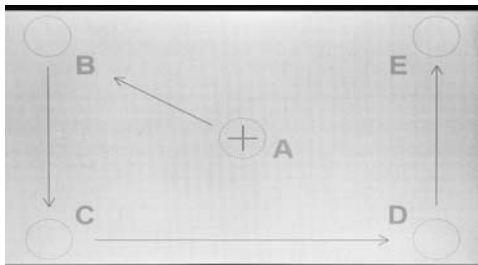

## CALIBRATION

 Premere per entrare nel menu CALIBRATION.

- La calibrazione avviene toccando lo schermo secondo la sequenza indicata.

## CALIBRATION

 Press icon to enter in the CALIBRATION menu.

- Calibration starts by touching the screen and following numbers sequence.



## PERSONALIZZAZIONE SFONDO

 Premere per entrare nel menu WALLPAPER.

- Selezionare lo sfondo tra quelli presenti.
- CUSTOM Per caricare fondi personalizzati. I files devono essere in formato BMP con risoluzione 800x480 e caricati tramite una Micro SD Card inserendola nello slot GPS.

## PERSONALIZING THE BACKGROUND (Wallpaper)

 Press to enter the WALLPAPER-menu.

- Select one of the given background-possibilities.
- CUSTOM Charging backgrounds of your own choice. Files have to be in BMP-format, 800x480-resolution, charged on a micro-SD-card you introduce into the GPS-slot.



## REGOLAZIONE DATA E ORA

 Premere per entrare nel menu TIME.

- Posizionarsi sulla voce da modificare ed effettuare le modifiche.

## SETTING DATE AND TIME

 Touch to enter in the menu TIME.

- Touch the function required and change values.





## GENERAL

☰ Premere per entrare nel menu General.

- OSD Imposta lingua sistema.
- Screensaver Imposta salvaschermo.
- Beep Attiva/disattiva suono tasti.
- Lighting Detect Attiva/disattiva riconoscimento luce ambiente.

## GENERAL

☰ Press to enter the General Menu.

- OSD Setting the System-Language.
- Screensaver Setting the screen-saver-function.
- Beep Activating/deactivating the key-tone.
- Lighting Detect Activating/deactivating light recognition-system



## BLUETOOTH

📶 Premere per entrare nel menu Bluetooth.

- Auto connect Attiva/disattiva connessione automatica.
- Auto answer Attiva/disattiva risposta automatica.
- Pairing code Cambia codice PIN per l'accoppiamento del telefono (0000 di fabbrica).

## BLUETOOTH

📶 Press to enter the Bluetooth-menu.

- Auto connect Activating/deactivating the automatic connection.
- Auto answer Activating/deactivating the automatic answer.
- Pairing code Changing the PIN-code for phone-pairing (0000 factory-code).

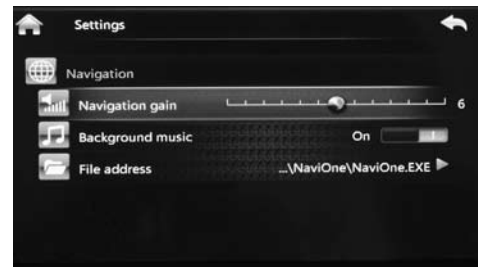

## NAVIGATION

🌐 Premere per entrare nel menu Navigation.

- Navigation gain Regola il volume degli avvisi di navigazione.
- Background music Permette l'ascolto dell'audio quando interviene un'avviso di navigazione.
- File address File esecutivo di navigazione, impostare mobilenavigator.exe.

## NAVIGATION

🌐 Press to enter the Navigation-menu.

- Navigation gain Setting the Volume of Navigation-announcements.
- Background music Allowing Audio-listening when Navigation-announcements arrive.
- File address Execution-file for Navigation. Select mobilenavigator.exe.



## NAVIGAZIONE

Alla prima attivazione della mappa iGO (optional) selezionare il file esecutivo mobilnavigator.exe nei settaggi.

- Accedere al menu impostazioni del software.

## NAVIGATION

When iGO-maps (Optional) are put into operation for the first time, you have to select the executive file mobilnavigator.exe and its settings.

- Enter the Software-Setup-Menu.



## IMPOSTAZIONE MODULO GPS



- Passa alla seconda schermata

## SETTING THE GPS-MODULE



- Go to the second panel



- Premere GPS.



- Press GPS.



- Premere sulla spunta di GPS ATTIVO poi su RILEVAMENTO AUTOMATICO.

- Press to tick GPS-ACTIVE then press AUTOMATIC REVEALING.



- Attendere l'acquisizione dei dati e premere ok.
- Riferirsi al manuale iGO per le istruzioni sul software di navigazione.

- Wait for Data-collection and press ok.
- Check iGO-Manual and follow the related navigation-software instructions.



## VIDEO

⊙ Premere per entrare nel menu Video.

- Video input seleziona sistema ingresso video: AUTO/PAL/NTSC/SECAM
- Rear camera Imposta la visione normale o a specchio della retrocamera.
- Parking Attiva/disattiva la visione video in movimento.
- Aspect ratio Seleziona formato video: 4:3-16:9.

## VIDEO

⊙ Press to enter the Video-menu.

- Video input Selecting Video-Input-System: AUTO/PAL/NTSC/SECAM
- Rear camera Selecting Rear-camera-view: Normal / Mirrow.
- Parking Activating/deactivating Video-reproduction while in movement.
- Aspect ratio Selecting Video-Formats: 4:3-16:9.



## SOUND

🔊 Premere per entrare nel menu Sound.

- Subwoofer filter Taglio di frequenza PASSA BASSO per uscita subwoofer 80/120/160 Hz.
- Subwoofer output Attiva/disattiva uscita.
- DRC Attiva/disattiva DRC.

## SOUND

🔊 Press to enter the Sound-menu.

- Subwoofer filter Select LOW-PASS Frequency-Cut for Subwoofer-Output: 80/120/160 Hz.
- Subwoofer output Activating/deactivating Exit.
- DRC Activating/deactivating DRC.



## SECURITY

🛡️ Premere per entrare nel menu Security.

- Rating level Imposta livello di sicurezza per la visione dei filmati.
- Set password Imposta password per livello di sicurezza.
- Load factory Ripristina impostazioni fabbrica.

## SECURITY

🛡️ Press to enter the Security-menu.

- Rating level Setting the kinds' film-security-level.
- Set password Setting Password to operate security-levels.
- Load factory re-establish Factory-settings.



## FUNZIONI RADIO

- Con i tasti **◀▶** sulla radio o sul telecomando l'unità ricercherà automaticamente le stazioni.
- Ricerca manuale: Scorrere l'indicatore di frequenza.
- **(i)** Selezione Bande Radio 3 FM - 2 AM.

### Memorizzazione stazioni.

- **M** Premere e selezionare la memoria. Disponibilità di 6 memorie ogni banda.
- Per richiamare una stazione memorizzata premere sul tasto corrispondente.
- **Q** Scansione di tutte le frequenze.

## RADIO-FUNCTIONS

- *By using the keys **◀▶** and **▶▶**, on the car-radio or on the remote-control, the Stations will be searched automatically.*
- *For Manual Stations-research, scroll the Frequency-indicator.*
- **(i)** Select Radio-Bands: 3 FM - 2 AM.

### Memorizing the Stations.

- **M** Press and select Memory. Each Band offers 6 memory-possibilities.
- To get one of the memorized Stations, press corresponding key.
- **Q** Scrolling all Frequencies.



## FUNZIONI RADIO

- **AF** Ricerca di una frequenza alternativa con informazioni sullo schermo della stazione.
- **TA** Informazioni traffico.
- **PTY** Selezione tipo di programma musicale.
- **(i)** **LOC** Selezione le stazioni vicine o lontane.
- **ST** Trasmissione stereo.
- **EQ** Equalizzatore.

## RADIO-FUNCTIONS

- **AF** Research an alternative Frequency and show related Station-details on the screen.
- **TA** Traffic-Information.
- **PTY** Selecting type of musical program.
- **(i)** **LOC** Selecting near/distant Stations.
- **ST** Stereo-Transmission.
- **EQ** Equalizer.

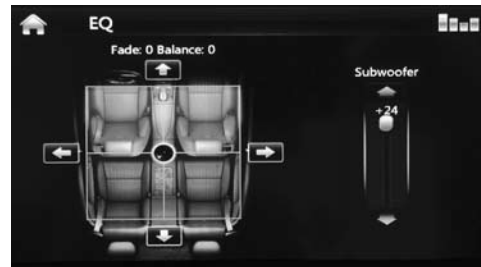

## EQUALIZZATORE

- **(i)** Fader e subwoofer.
- **◀User▶** Selezione EQ: FLAT/POP/CLASSIC JAZZ/VOCAL/DANCE/USER
- **(i)** Ripistina i valori originali.
- Regola **FADER** e **BILANCIAMENTO**.
- Regola livello **SUBWOOFER**.

## EQUALIZER

- **(i)** Fader and Subwoofer.
- **◀User▶** Select EQ: FLAT/POP/CLASSIC JAZZ/VOCAL/DANCE/USER
- **(i)** Re-establish Original settings.
- Setting **FADER** and **BALANCE**.
- Setting **SUBWOOFER**-level.



### FUNZIONI VIDEO DVD

- 1/2 Menù successivo.
- Zoom, ingrandisce e riduce immagine.
- Traccia precedente.
- Pausa e riproduzione.
- Traccia successiva.
- Menù titoli.

### VIDEO FUNCTIONS

- 1/2 *Menu after.*
- *Zoom, enlarge/reduce picture.*
- *Track before.*
- *Pause and Reproduce.*
- *Track after.*
- *Titles-menu.*

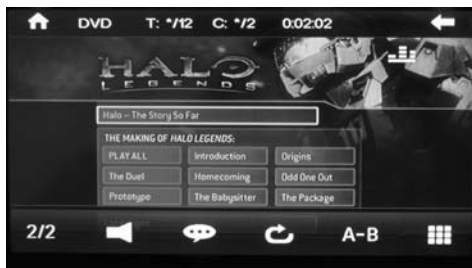

### FUNZIONI VIDEO DVD

- 2/2 Menù precedente.
- Lingua audio.
- Sottotitoli.
- Ripetizione traccia/capitolo/disco
- **A-B** Ripetizione dal punto A al punto B.
- Tastiera per selezione capitoli.

### VIDEO FUNCTIONS

- 2/2 *Menu before.*
- *Audio-Language.*
- *Sub-Titles.*
- *Repeat Track/Chapter/CD*
- **A-B** *Repeat from A to B.*
- *Key-board for Chapter-selection.*



### FUNZIONI VIDEO USB/SD CARD

Le prime 5 funzioni sono uguali al menù DVD

- Menù titoli.

### USB/SD-VIDEO-FUNCTIONS.

*The first 5 functions are identical with the DVD-menu.*

- *Titles-Menu.*



### FUNZIONI VIDEO USB/SD CARD

Uguale al menù DVD tranne che per la funzione .

### USB/SD-VIDEO-FUNCTIONS

*Identical with the DVD-menu, EXCEPT for the function .*



### RIPRODUZIONE MUSICA

- Visualizza file audio.
- Visualizza file immagini.
- Visualizza file video.
- Muovi su.
- Muovi giù.
- Tastiera per selezionare traccia.

### MUSIC-REPRODUCTION

- Visualize Audio-file.
- Visualize Pictures-file.
- Visualize Video-file.
- Move up.
- Move down.
- Key-board to select Track.



### RIPRODUZIONE MUSICA

- Riproduzione casuale
- Ripeti traccia.
- Traccia precedente.
- Pausa e riproduzione.
- Traccia successiva.
- Stop riproduzione.

### MUSIC-REPRODUCTION

- Random-reproduction.
- Repeat Track.
- Track before.
- Pause and Reproduce.
- Track after.
- Stop Reproduction.



### RIPRODUZIONE IMMAGINI

- Zoom, ingrandisce e riduce immagine.
- Rotazione immagine.
- Traccia precedente.
- Pausa e riproduzione.
- Traccia successiva.
- Velocità riproduzione immagini  
NORMAL/FAST/LOW

### PICTURES-REPRODUCTION

- Zoom, enlarging/reducing picture.
- Rotate Picture.
- Track before.
- Pause and Reproduce.
- Track after.
- Speed for Pictures-Reproduction  
NORMAL/FAST/LOW



## ACCOPPIAMENTO TELEFONO

E' possibile accoppiare fino a 5 telefoni.

- Attivare la funzione bluetooth sul telefono e ricercare nuovi dispositivi.
  - Selezionare **FW3307** nella lista dispositivi, inserire la password 0000 quando richiesta.
- Ad accoppiamento avvenuto comparirà il nome del telefono.

## COUPLING MOBILE-PHONE

You can couple up to 5 mobile-phones.

- Activate the Bluetooth-function on the mobile-phone and search for other devices.
  - Select **FW3307** from the device-list, insert the password 0000 when requested.
- When coupling-process is completed, the phone-name will appear.

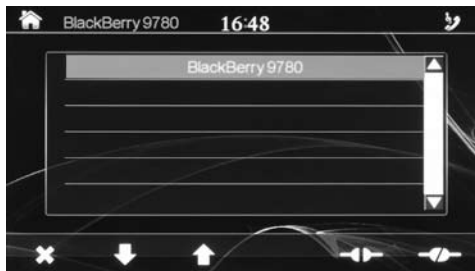

## DISPOSITIVI ACCOPPIATI

- Premere per disconnettere il telefono.
- Premere per riconnettere.
- Sconnette e cancella dall'elenco

## COUPLED DEVICES

- Press to disconnect the mobile-phone.
- Press to re-connect.
- Disconnect and delete from List.



## CHIAMARE DALLO SCHERMO

- Premere una delle icone presenti sullo schermo per chiamare da uno degli elenchi.
- Chiamate perse - Chiamate ricevute
- Chiamate effettuate
- Rubrica telefonica. Selezionare il numero e premere .
- Chiamata dal tastierino numerico. Digitare il numero e premere .
- Cancella ultimo numero digitato.
- Cancella tutti i numeri digitati.

## STARTING A PHONE-CALL FROM THE SCREEN





- Press one of the icons available on the screen, to start call from one of the phone-lists.
- Calls lost - Calls received
- Calls effected - Phone-List. Select phone-number and press .
- Starting call from number-keys. Digit phone-number and press .
- Cancel last dialed phone-number.
- Cancel all dialed phone-numbers.









## RICEVERE UNA CHIAMATA

Quando è in arrivo una chiamata, il VM033 passa automaticamente in modalità bluetooth.

-  per rispondere.
-  per terminare o rifiutare la chiamata.
-  per escludere o attivare il vivavoce.
-  per attivare o disattivare il microfono.

## RECEIVING A PHONE-CALL

*When a phone-call arrives, the VM033 automatically switches to Bluetooth-function.*

-  *To answer the phone.*
-  *To end or refuse a phone-call.*
-  *To exclude or activate the hands-free function.*
-  *To activate or de-activate the microphone.*



## RIPRODUZIONE MUSICA BLUETOOTH

Se il telefono connesso supporta il profilo A2DP è possibile ascoltare i brani musicali.



Se il dispositivo supporta AVRCP sarà possibile controllare i brani musicali direttamente dal touch screen.

-   Brano precedente/successivo.
-  Avvia/interrompe la riproduzione.

## MUSIC-REPRODUCTION THROUGH BLUETOOTH

*If the mobile-phone supports the A2DP-profile, musical tracks can be reproduced.*

*If the mobile-phone supports AVRCP, the musical tracks can be operated directly on the Touch-screen.*

-   *Track before/after.*
-  *Start/Interrupt reproduction.*

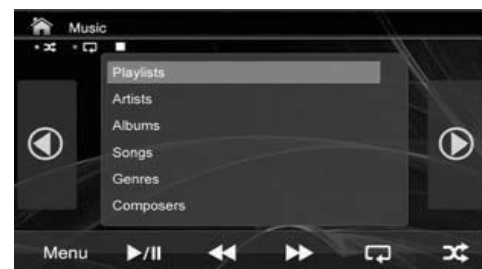

## IPOD

Collegando il prodotto Apple tramite il cavo in dotazione, si visualizza automaticamente la schermata iPod. Scegliere la propria musica secondo le playlist e gli album tramite il touch screen.

Supporta tutta la gamma iPod e iPhone (3G-3GS-4-4S).

## IPOD

*By connecting the Apple-device through the supplied cable, the i-Pod-menu will automatically appear. Select your own music on the Touch-screen, by choosing from the Playlists and Albums. Supports all i-Pod and i-Phone-models. (3G-3GS-4-4S).*



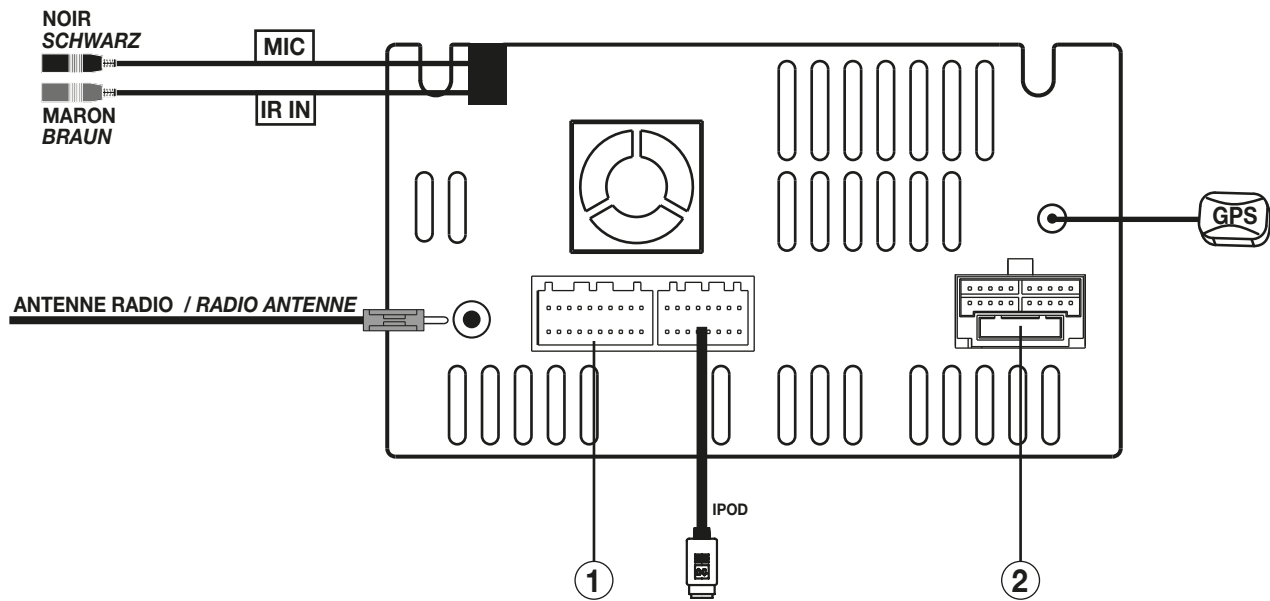

## 1 SORTIE-ENTRÉES AUDIO/VIDEO / AUSGANG-EINGANG AUDIO/VIDEO



## 2 SORTIE HAUT-PARLEURS - COMMANDES AU VOLANT - SERVICES / LAUTSPRECHER-AUSGÄNGE - LENKRAD-STEUERUNGEN - FUNKTIONEN

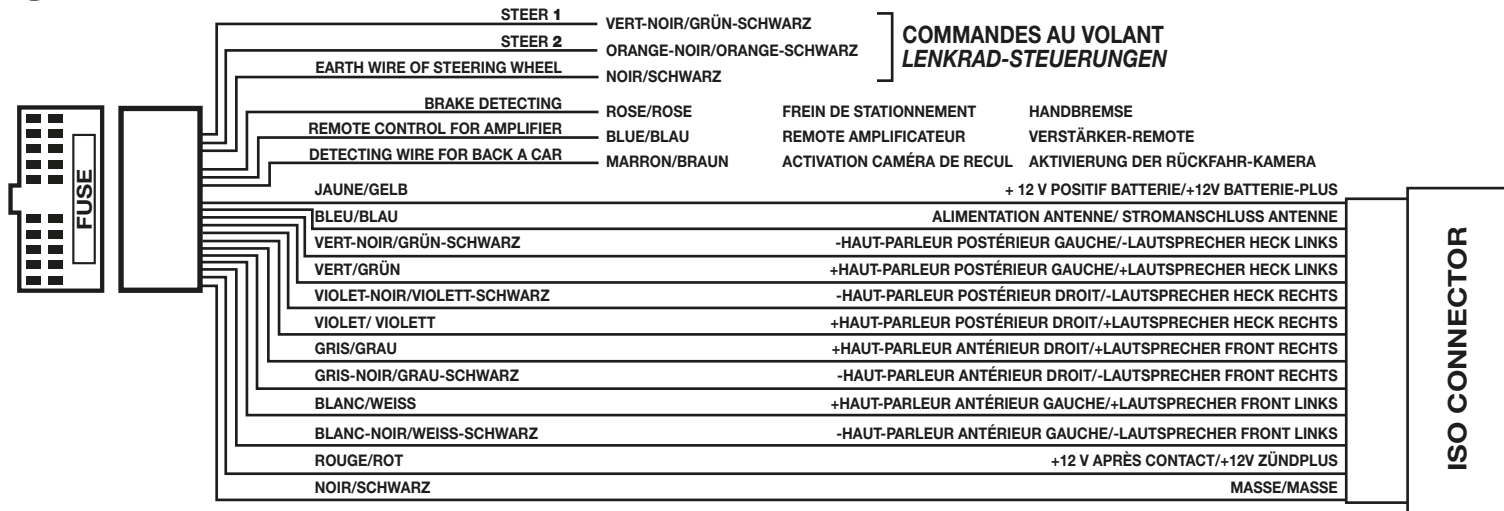



1. Slot Micro SD **pour la navigation**
2. Touche Reset
3. Navigation - Expulsion CD\*
4. Hausse le volume
5. Capteur IR
6. Baisse le volume
7. Allumage - Mute
8. Porte Mini USB à utiliser alternativement à celle postérieure
9. Slot SD Carte
10. Fente insertion CD

1. **Öffnung für Navigations-Mikro-SD**
2. *Reset-Taste*
3. *Navigations - CD-Auswurf \**
4. *Lautstärke erhöhen*
5. *IR-Sensor*
6. *Lautstärke reduzieren*
7. *Ein/Stummschaltung (Mute)*
8. *Mini-USB-Öffnung, als Alternative zur rückwärtigen USB-Öffnung verwendbar.*
9. *SD-Öffnung*
10. *CD-Eingabe*

\*Faire pression pendant 2 secondes pour lancer la navigation. - \*2 Sekunden drücken, so dass die Navigation startet.

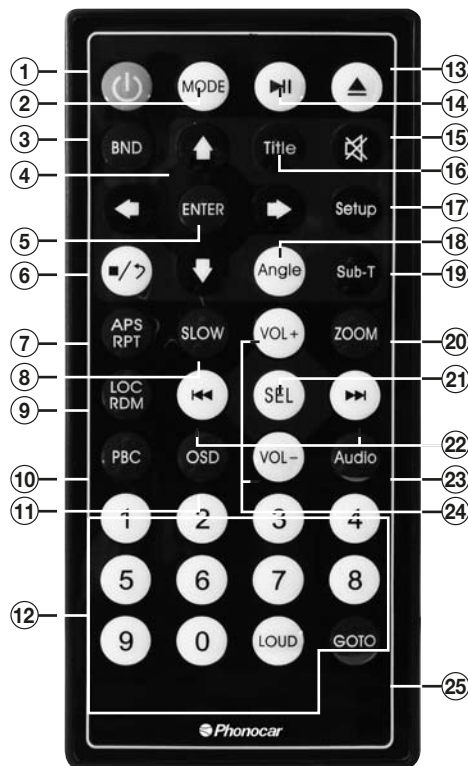

1. Allumage / Extinction
2. Change source
3. Bande radio
4. Flèches directionnelles pour parcourir le menu
5. Confirme sélection
6. Interrompt / relance la reproduction
7. Répétition trace / Chapitre / CD
8. Reproduction ralentie
9. Réception Stations locales radio / reproduction casuelle en reproduction CD / USB, micro Carte SD
10. En modalité DVD – VCD apparaissent sur l'écran les traces du CD et c'est possible les sélectionner directement. **Fonction disponible uniquement sur supports DVD avec PBC.**
11. Montre les informations de reproduction sur l'écran
12. Clavier numérique
13. Expulsion CD
14. Pause / commence la reproduction
15. Met à zéro l'audio
16. Menu principal DVD
17. Réglages De Systeme
18. Change l'angle de vision DVD
19. Sous-titres DVD
20. Agrandi / réduit l'image
21. Réglage tons / équilibre audio / EQ
22. Trace / station radio précédente / Successive
23. Audio DVD (Langue)
24. Réglage Volume
25. Commence la reproduction à partir du point désiré

1. Ein-/Ausschalten
2. Quelle wählen.
3. Radio-Band.
4. Richtungs-Tasten für die Menü-Bewegungen.
5. Wahl bestätigen.
6. Wiedergabe unterbrechen/wiederaufnehmen
7. Stück/Kapitel/CD wiederholen
8. Langsame Wiedergabe.
9. Empfang lokaler Radio-Sender / wahllose Wiedergabe bei CD/USB/Mikro-SD-Betrieb.
10. Während des DVD-VCD-Betriebs werden die verschiedenen Musik-Stücke auf dem Bildschirm ausgewiesen und können daher auch direkt gewählt werden. **Diese Funktion ist nur bei DVDs mit PBC gewährleistet.**
11. Wiedergabe-Infos auf dem Bildschirm ausweisen.
12. Nummern-Tasten.
13. CD-Auswurf
14. Wiedergabe Stoppen/Wiederaufnehmen.
15. Stumm-Schaltung.
16. DVD-Hauptmenü.
17. System-Einstellungen
18. DVD-Sichtwinkel-Einstellungen
19. Untertitel.
20. Bild-Vergrößerung/-Verkleinerung.
21. Ton/Balance-Einstellungen bei Audio/EQ.
22. Stück/Radiosender davor/danach.
23. DVD-Audio (Sprache).
24. Lautstärke-Regelung.
25. Von einem gewünschten Punkt ausgehend, Wiedergabe starten.

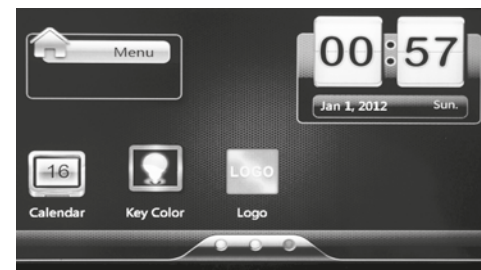

Après l'allumage, le dispositif entre automatiquement dans la fonction radio. Appuyer  pour entrer dans le menu principal. Appuyer ● ● ● les touches pour tourner la page du menu, de droite à gauche ou effectuer le défilement manuel.

Appuyer l'icône  Settings pour entrer dans les menus des réglages du système.

Nach dem Einschalten, startet das Gerät automatisch im Radio-Betrieb.  Drücken, um das Haupt-Menü zu betreten. Tasten ● ● ● drücken, um die Menü-Seiten, von rechts nach links, durchzugehen. Oder aber manuelles Scrolling vornehmen.

Setting-Ikone drücken , um System-Einstellungs-Menü zu betreten.

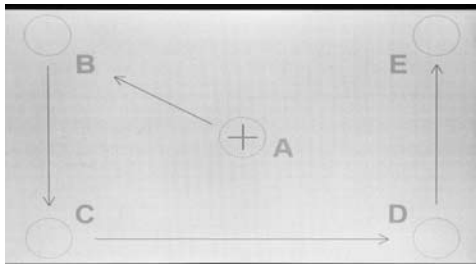

## CALIBRATION

 Appuyer pour entrer dans le menu CALIBRATION.

- Le calibrage se fait en touchant l'écran selon la séquence indiquée.

## CALIBRATION

 Drücken, um das WALLPAPER-Menü zu betreten.

- Die Kalibrierung erfolgt auf dem Touchscreen, in der angezeigten Reihenfolge.



## PERSONNALISATION FOND D'ECRAN

 Appuyer pour entrer dans le menu WALLPAPER.

- Choisir le fond parmi ceux présents.
- CUSTOM Pour charger les fonds personnalisés.

Les fichiers doivent être sous format BMP avec résolution 800x480 et chargés moyennant une micro carte SD insérer dans la slot GPS.

## BILDSCHIRM-HINTERGRUND (Wallpaper) PERSONNALISIEREN

 Drücken, um das WALLPAPER-Menü zu betreten.

- Aus den verfügbaren Hintergrund-Bildern wählen.
- CUSTOM Personalisierte Hintergrund-Bilder laden.

Die Dateien müssen dem BMP-Format entsprechen, Auflösung 800x480, und auf einer Mikro-SD-Karte gespeichert sein, die dann in die GPS-Öffnung eingegeben wird.



## REGLAGE DATE ET HEURE

 Appuyer pour entrer dans le menu TIME.

- Se placer sur le paramètre à modifier et faire les changements.

## EINSTELLUNG VON DATUM / UHRZEIT

 Drücken, um das TIME-Menü zu betreten.

- Auf die gewünschte Position gehen und die notwendigen Daten abändern.



## GENERALE

**☰** Appuyer pour entrer dans le menu général.

- OSD Règle la langue du système.
- Screensaver Règle l'écran de veille.
- Beep Active/désactive le son des touches.
- Lighting Detect Active/désactive la reconnaissance de la lumière ambiante.

## GENERAL-FUNKTIONEN

**☰** Drücken, um das General-Menü zu betreten.

- OSD System-Sprache einstellen.
- Screensaver Bildschirm-Schoner einstellen.
- Beep Tasten-Ton aktivieren/deaktivieren.
- Lighting Detect Raum-Beleuchtungs Erkennung aktivieren/deaktivieren.



## BLUETOOTH

**📶** Appuyer pour entrer dans le menu Bluetooth.

- Auto connect Active/désactive la connexion automatique.
- Auto answer Active/désactive la réponse automatique.
- Pairing code Change le code PIN pour le paramétrage du téléphone (0000 d'origine).

## BLUETOOTH

**📶** Drücken, um das Bluetooth-Menü zu betreten.

- Auto connect Automatische Verbindung aktivieren/deaktivieren.
- Auto answer Automatische Beantwortung aktivieren/deaktivieren.
- Pairing code PIN-code-Nr. für die Telefon-Koppelung ändern (0000 Fabrik-Einstellung).

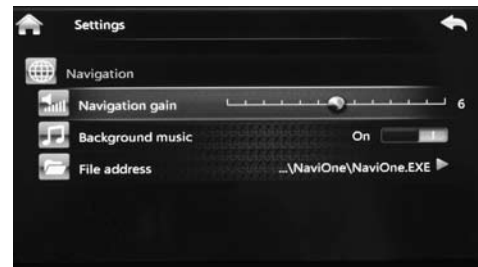

## NAVIGATION

**🌐** Appuyer pour entrer dans le menu de Navigation.

- Navigation gain Règle le volume des annonces de navigation.
- Background music Permet l'écoute de l'audio quand intervient une annonce de la navigation.
- File address Fichier exécutif de navigation, programmer mobilenavigator.exe.

## NAVIGATION

**🌐** Drücken, um das Navigations-Menü zu betreten.

- Navigation gain Lautstärke für die Navigations Stimme.
- Background music Audio-Wiedergabe bei Navigations-Hinweisen.
- File address Navigations-Abwicklungsdatei; mobilenavigator.exe. einstellen.



## NAVIGATION

Quand on active pour la première fois la carte iGo (optionnel), il faut sélectionner le fichier exécutable mobilenavigator.exe dans les réglages.

- Accéder au menu paramètre du software.

## NAVIGATION

Bei der Erst-Aktivierung der iGO-Mappen (Optional), die Betriebs-Datei mobilenavigator.exe wählen und Einstellungen vornehmen.

- Das Software-Einstellungs-Menü betreten.



## PARAMÈTRE MODULE GPS



- Passer au second écran.

## EINSTELLUNG DES GPS-MODULS



- Auf die zweite Seite gehen.



- Appuyer GPS.



- GPS drücken



- Appuyer sur le trait de GPS ACTIF, Et après sur le RELÈVEMENT AUTOMATIQUE.

- GPS-AKTIV drücken bzw. abhaken. Dann auf AUTOMATISCHE ERKENNUNG drücken.



- Attendre l'acquisition des données et appuyer ok.
- Faire référence au manuel iGo pour les instructions sur le software de navigation.

- Die Ermittlung der Daten abwarten und OK drücken.
- Die Anweisungen zur Navigations-Software sind dem iGO-Handbuch zu entnehmen.





## VIDEO

- Appuyer pour entrer dans le menu Vidéo.
- Vidéo Input sélectionne le système d'entrée vidéo: AUTO/PAL/NTSC/SECAM
- Rear camera Règle la vision normal ou miroir de la caméra de recul.
- Parking Active/désactive la vidéo en mouvement.
- Aspect ratio Sélectionne le format vidéo: 4:3-16:9.

## VIDEO

- Drücken, um das Video-Menü zu betreten.
- Video input Video-Eingangssystem wählen: AUTO/PAL/NTSC/SECAM
- Rear camera Rückfahrkamera-Ansicht wählen: Normal / Mirror (Spiegelbild)
- Parking Video-Freischaltung aktivieren/deaktivieren
- Aspect ratio Video-Format wählen: 4:3-16:9.



## SOUND

- Appuyer pour entrer dans le menu Sound.
- Subwoofer filter Coupure de fréquence PASSE BASSE Pour sortie subwoofer 80/120/160 Hz.
- Subwoofer Output active/désactive la sortie.
- DRC Active/désactive DRC.

## SOUND

- Drücken, um das Sound-Menü zu betreten.
- Subwoofer filter TIEF-PASS Trenn-Frequenz für Subwoofer-Ausgang wählen: 80/120/160 Hz.
- Subwoofer output Ausgang aktivieren/deaktivieren.
- DRC Aktivierung/Deaktivierung von DRC



## SECURITY

- Appuyer pour entrer dans le menu Security.
- Rating level Règle le niveau de sécurité pour la vision des films.
- Set password Règle le mot de passe pour le niveau de sécurité.
- Load factory Restaure les règles d'origine.

## SECURITY

- Drücken, um das Security-Menü zu betreten.
- Rating level Jugendschutz-Einstufung für die Film-Besichtigung.
- Set password Passwort-Festlegung zwecks Jugendschutz-Einstufung.
- Load factory Fabrik-Einstellungen wieder aufnehmen.



## FONCTIONS RADIO

- Avec les touches **und** sur la radio ou sur la télécommande, l'appareil recherchera automatiquement les stations.
- Pour la recherche manuelle, faire glisser l'indicateur de fréquence.

- **(i)** Sélectionne Bande Radio 3 FM - 2 AM.

## Mémorisation stations.

- **(M)** Appuyer et sélectionner la mémoire. Disponibilité de 6 mémoires pour chaque bande.
- Pour rappeler une station mémorisée, appuyer sur la touche correspondante.
- **(R)** Scanning de toutes les fréquences.

## RADIO-FUNKTIONEN

- Durch die Taste **und**, auf dem Radio oder der Fernbedienung, startet die Sendersuche automatisch.
- Bei manueller Sendersuche, Frequenz-Anzeiger scrollen.
- **(i)** Radio-Frequenz-Band wählen: 3 FM-2 AM.

## Einspeicherung der Radio-Sender.

- **(M)** Taste drücken und Einspeicherung vornehmen. Jedes Frequenz-Band verfügt über 6 Speicher-Möglichkeiten.
- Um einen eingespeicherten Sender zu wählen, die entsprechende Taste drücken.
- **(R)** Alle Frequenzen scrollen.



## FONCTIONS RADIO

- **AF** Recherche d'une station alternative avec les informations de la station sur l'écran.
- **TA** Informations sur la circulation.
- **PTY** Sélectionne le type de programme musical.
- **(i)** **LOC** Sélectionne les stations voisines ou lointaines.
- **(S)** **ST** Transmission stéréo.
- **(R)** Egaliseur.

## RADIO-FUNKTIONEN

- **AF** Suche Alternativ-Frequenz mit Ausweisung der Sender-Infos.
- **TA** Verkehrs-Infos.
- **PTY** Musik-Programm-Art wählen.
- **(i)** **LOC** Nahe / entfernte Sender wählen.
- **(S)** **ST** Stereo-Wiedergabe
- **(R)** Equalizer

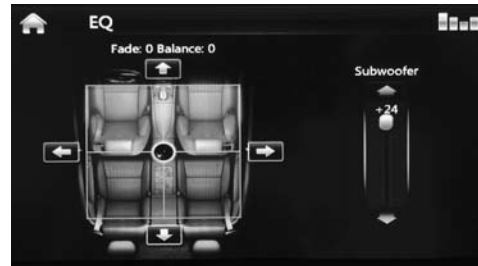

## EGALISEUR

- **(F)** Fader et subwoofer.
- **(User)** Sélectionne EQ: FLAT/POP/CLASSIC JAZZ/VOCAL/DANCE/USER
- **(R)** Restaure les valeurs originaux.
- Règle FADER e EQUILIBRAGE.
- Règle niveau SUBWOOFER.

## EQUALIZER

- **(F)** Fader und Subwoofer.
- **(User)** EQ-Einstellung: FLAT/POP/CLASSIC JAZZ/VOCAL/DANCE/USER
- **(R)** Fabrik-Einstellungen wieder herstellen.
- Einstellung von FADER und BALANCE.
- SUBWOOFER-Niveau einstellen.



### FONCTIONS VIDEO DVD

- 1/2 Menu successif.
- Zoom, agrandi et réduit l'image.
- Trace précédente.
- Pause et reproduction.
- Trace successive.
- Menu titres.

### DVD-VIDEO-FUNKTIONEN

- 1/2 Menü danach.
- Zoom, Bilder vergrößern / verkleinern.
- Stück davor.
- Pause und Wiedergabe.
- Stück danach.
- Titel-Menü.

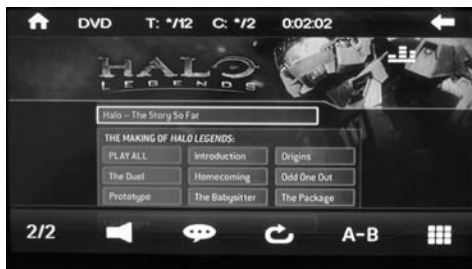

### FONCTIONS VIDEO DVD

- 2/2 Menu précédent.
- Langue audio.
- Sous-titres.
- Répétition trace/chapitre/disque
- **A-B** Répétition du point A au point B.
- Clavier pour choisir les chapitres.

### DVD-VIDEO-FUNKTIONEN

- 2/2 Menü davor.
- Audio-Sprache.
- Unter-Titel.
- Wiederhole Stück/Kapitel/CD.
- **A-B** Wiederhole von A bis B.
- Tastatur für die Kapitel-Wahl.



### FONCTIONS VIDEO USB/SD CARD

Les 5 premières fonctions sont égales au menu DVD

- Menu titres.

### USB/SD-VIDEO-FUNKTIONEN

Die ersten 5 Funktionen decken sich mit dem DVD-Menü.

- Titel-Menü.



### FONCTIONS VIDEO USB/SD CARD

Egale au menu DVD à exception de la fonction .

### USB/SD-VIDEO-FUNKTIONEN

Wie im DVD-Menü angegeben, ausgenommen davon die Funktion .



### REPRODUCTION MUSIQUE

- Visualise les fichiers audio.
- Visualise les fichiers images.
- Visualise les fichiers vidéo.
- Déplace vers le haut.
- Déplace vers le bas.
- Clavier pour sélectionner la trace.

### MUSIK-WIEDERGABE

- Audio-Datei ausweisen.
- Bilder-Datei ausweisen.
- Video-Datei ausweisen.
- Nach oben.
- Nach unten.
- Tastatur für die Wahl der Musik-Stücke.



### RIPRODUZIONE MUSICA

- Riproduzione casuale
- Ripete trace.
- Trace précédente.
- Pause et reproduction.
- Trace successive.
- Stop reproduction.

### MUSIK-WIEDERGABE

- Wahllose Wiedergabe
- Wiederhole Stück.
- Stück davor.
- Pause und Wiedergabe.
- Stück danach.
- Wiedergabe stoppen.



### REPRODUCTION PHOTOS

- Zoom, agrandi et réduit l'image.
- Rotation image.
- Trace précédente.
- Pause et reproduction.
- Trace successive.
- Vitesse reproduction images.  
NORMAL/FAST/LOW

### BILDER-WIEDERGABE

- Zoom, Bilder vergrößern / verkleinern.
- Bild drehen.
- Stück davor.
- Pause und Wiedergabe.
- Stück danach.
- Geschwindigkeit bei der Bilder-Wiedergabe.  
NORMAL/FAST/LOW



## PARAMETRAGE TELEPHONE

C'est possible paramétrer jusqu'à 5 téléphones.

- Activer la fonction bluetooth sur le téléphone et rechercher des nouveaux dispositifs.
- Sélectionner **FW3307** dans la liste des dispositifs, Insérer le mot de passe 0000 au moment demandé. Lorsque le paramétrage est fait, le nom du téléphone apparaît.

## MOBIL-TELEFON ANKOPPELN

Es lassen sich maximal 5 Mobil-Telefone ankoppeln.

- Bluetooth-Funktion auf dem Mobil-Telefon aktivieren und andere Geräte suchen.
  - Aus der Geräte-Liste, **FW3307** wählen. Auf Anfrage, Passwort 0000 eingeben.
- Sobald die Koppelung erfolgreich abgeschlossen ist, wird der Telefon-Name angezeigt.

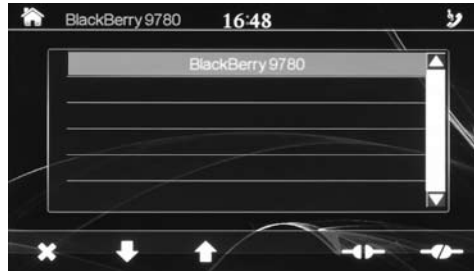

## DISPOSITIFS PARAMETRES

- ☞ Appuyer pour déconnecter le téléphone.
- ☞ Appuyer pour reconnecter.
- ✗ Déconnecte et efface de la liste

## GEKOPPELTE GERÄTE

- ☞ Drücken, um die Verbindung des Mobil-Telefons zu unterbrechen.
- ☞ Drücken, um Verbindung wieder herzustellen.
- ✗ Verbindung unterbrechen und von der Liste löschen.



## APPELER A PARTIR DE L'ECRAN

- Appuyer une des icônes présentes sur l'écran pour appeler à partir d'une des listes.
  - ☞ Appels perdus - ☞ Appels reçus
  - ☞ Appels effectués - ☞ Répertoire téléphonique
- Sélectionner le numéro et appuyer ☞.
- Appel à partir du clavier numérique.
  - Taper le numéro et appuyer ☞.
- ☞ Efface le dernier numéro tapé.
  - ☞ Efface tous les numéros tapés.

## TELEFONAT VOM BILDSCHIRM AUS STARTEN

- Auf dem Bildschirm, eine der verfügbaren Ikonen drücken, um ein Telefonat aus einem der Telefon-Register zu starten.
  - ☞ Verlorene Telefonate - ☞ Beantwortete Telefonate
  - ☞ Gestartete Telefonate - ☞ Telefon-Register
- Rufnummer wählen und drücken ☞.
- Telefonat mit Nummertasten starten.
  - Rufnummer wählen und drücken ☞.
  - ☞ Zuletzt gewählte Rufnummer löschen.
  - ☞ Alle angewählten Rufnummern löschen.



### RECEVOIR UN APPEL

Lorsqu'un appel est reçu, le VM033 passe automatiquement en modalit  bluetooth.

- ☎ Pour r pondre.
- ☎ Pour terminer ou refuser l'appel.
- ⌚ Pour exclure ou activer la mains-libres.
- 🔊 Pour activer ou d sactiver le micro.

### EINGEHENDE TELEFONATE

*Sobald ein Telefonat ankommt, schaltet der VM033 automatisch auf die Bluetooth-Funktion.*

- ☎ Telefonat annehmen.
- ☎ Telefonat beenden oder abweisen.
- ⌚ Freisprech-Funktion ausschlieen oder aktivieren.
- 🔊 Mikrofon aktivieren / de-aktivieren.



### REPRODUCTION MUSIQUE BLUETOOTH

Si le t l phone connect  supporte le profil A2DP, c'est possible  couter les chansons.

Si le dispositif supporte AVRCP, il sera possible contr ler les chansons directement   partir de l' cran tactile.

- ⏮ / ⏭ Chanson pr c dente/succive.
- ▶|| Commence /interrompt la reproduction.

### MUSIK-WIEDERGABE DURCH BLUETOOTH

*Wenn das Mobil-Telefon kompatibel ist mit dem Profil A2DP, dann lassen sich auch Musikst cke abspielen.*

*Wenn das Mobil-Telefon kompatibel ist mit dem Profil AVRCP, dann lassen sich die Musik-Titel direkt auf dem Touch-screen bedienen.*

- ⏮ Titel vor ▶▶ Titel zur ck.
- ▶|| Wiedergabe starten / unterbrechen.



### I-POD

En branchant le produit Apple gr ce au c ble offert, la page- cran iPod se visualise automatiquement.

A travers l' cran tactile, Choisir la musique selon les playlist et les albums.

Supporte toute la gamme iPod et iPhone (3G-3GS-4-4S).

### I-POD

Schliet man das Apple-Ger t mit Hilfe des beigelegten Kabel an, so erscheint automatisch das iPod-Men . Auf dem Touch-Screen, die gew nschte Musik, aus den eigenen Playlists und Albums, w hlen. Kompatibel mit allen i-Pod und i-Phone-Modellen. (3G-3GS-4-4S).

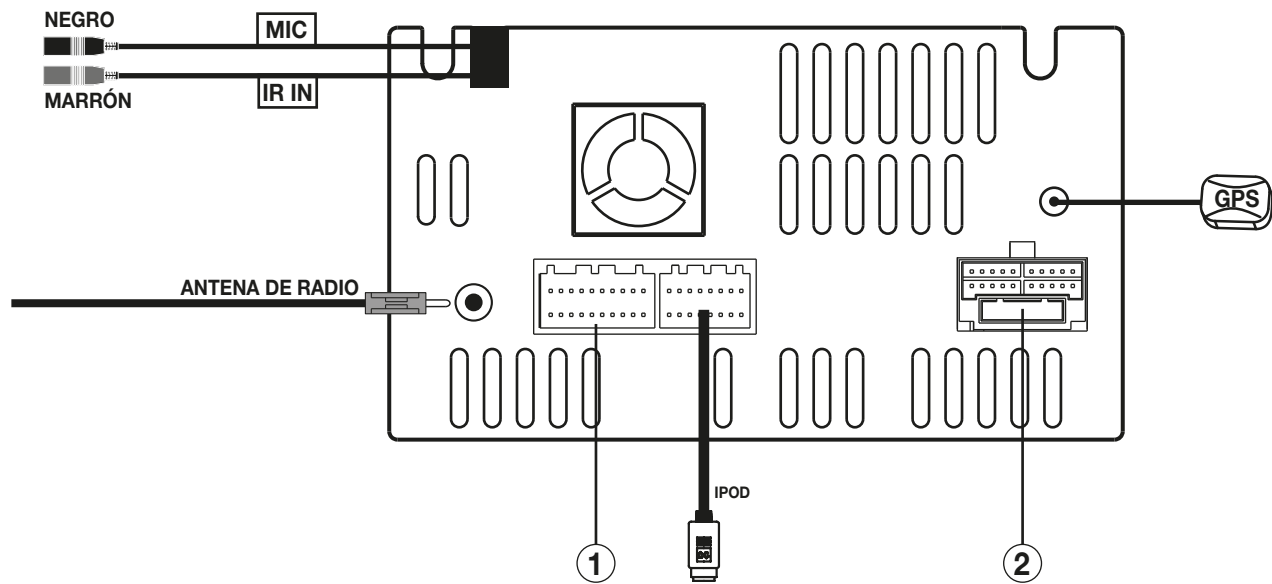

## 1 USCITE-INGRESSI AUDIO/VIDEO / OUTPUT-INPUT AUDIO/VIDEO



## 2 SALIDAS ALTAVOCES - MANDOS DE VOLANTE - SERVICIOS

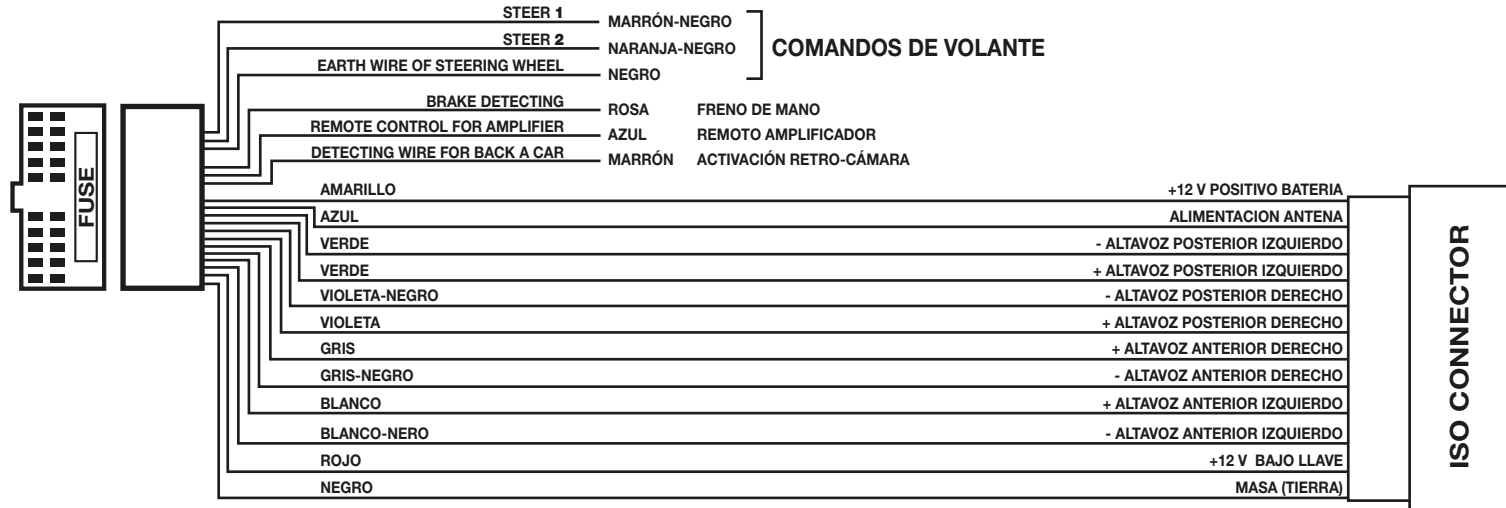





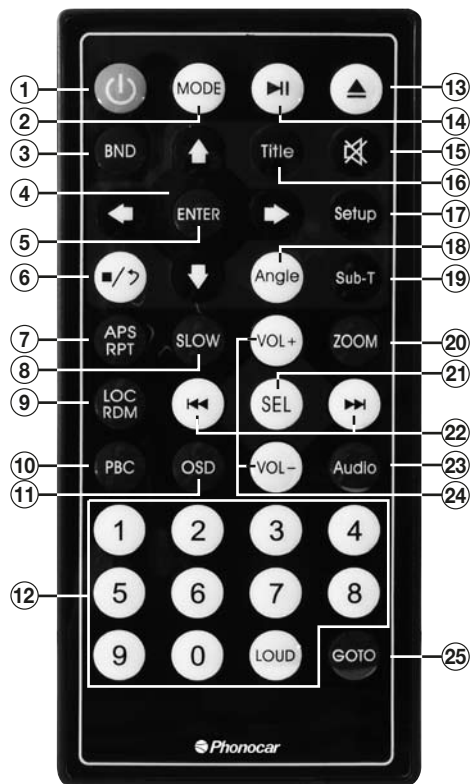

1. Ranura Micro SD para cartografía de navegación.
2. Tecla reset.
3. Navegación - Expulsión disco.\*
4. Sube el volumen
5. Sensor IR
6. Baja el volumen
7. Encendido - Mute
8. Puerto Mini-USB para utilizar en alternativa a la toma puesta en la parte posterior del aparato
9. Ranura SD card
10. Ranura disco.

\*Tener presionado durante 2 segundos para iniciar la navegación.

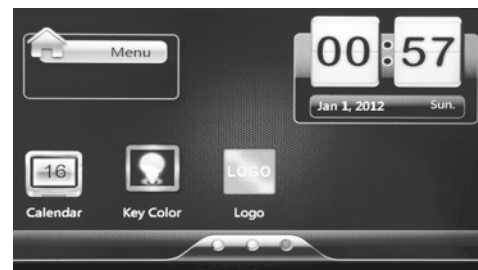

1. Encendido/apagado.
  2. Cambia fuente.
  3. Banda radio.
  4. Flechas direccionales para desplazarse en el menú.
  5. Confirma selección.
  6. Interrumpe/reinicia reproducción.
  7. Repetición pista/capitulo/disco.
  8. Reproducción ralentizada.
  9. Recepción emisoras locales radio/reproducción casual en reproducción Disco/USB Micro SD Card.
  10. En modo DVD-VCD aparecen en la pantalla las pistas del disco y es posible seleccionarl as directamente.
- Funciones disponible solo con soportes DVD PCB.**
11. Muestra la información para su reproducción en la pantalla.
  12. Teclado numérico.
  13. Expulsión disco.
  14. Inicia/Interrumpe reproducción.
  15. Silenciamiento audio.
  16. MENU' DVD.
  17. Ajustes del sistema.
  18. Cambia ángulo de visión DVD.
  19. Subtítulos DVD.
  20. Aumenta/disminuye imagen.
  21. Ajustes tonos/balance audio/EQ.
  22. Pista/Emisoras de radio anterior/siguiente.
  23. Audio DVD (idioma).
  24. Ajuste volumen.
  25. Inicia reproducción desde el punto deseado.



El dispositivo después del encendido entra automáticamente en la función radio. Presionar  para entrar en el menú principal. Presionar las teclas

● ● ● para girar la pagina del menú de derecha a izquierda o para pasarlo manualmente.

Presionar el icono  Settings para entrar en los menús de los ajustes del sistema.

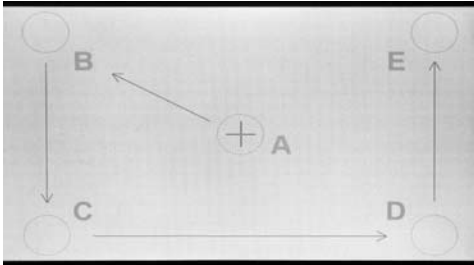

## CALIBRACION

-  Efectúa la calibración de la pantalla táctil.
- Utilizar el lapiz en dotación y tocar la pantalla en el simbolo “+” en el centro de la pantalla. Continuar con la secuencia hasta su completa calibración.



## PERSONALIZACIÓN DEL FONDO DE PANTALLA

-  Presionar para entrar en el menú WALLPAPER.
- Seleccionar el fondo entre los que se encuentran disponibles.
  - CUSTOM para cargar los fondos personalizados.

Los archivos deben ser en formato BMP con resolución 800x480 y cargados mediante una Micro SD Card introducida en la ranura GPS.



## AJUSTE DE FECHA Y HORA

-  Pulse para entrar en el menú HORA.
- Vaya a la opción que desea modificar y realice los cambios.



### GENERAL

- Presionar para entrar en el menú General.
- OSD configura el idioma del sistema.
- Screensaver Configura el salva pantalla.
- Beep activa/desactiva el sonido de las teclas.
- Lighting Detect activa/desactiva el reconocimiento de la luz ambiente.

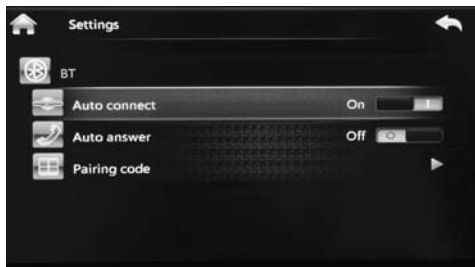

### BLUETOOTH

- Presionar para entrar en el menú Bluetooth.
- Auto connect activa/desactiva conexión automática.
- Auto answer activa/desactiva la contestación automática.
- Pairing code cambia el código PIN para poder emparejar el teléfono (0000 de fábrica).

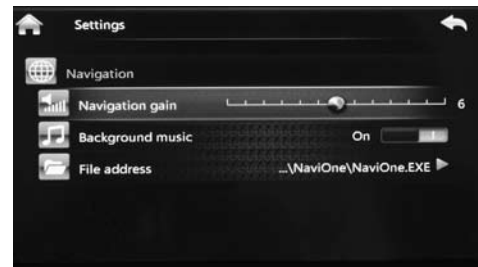

### NAVEGACIÓN

- Presionar para entrar en el menú Navegación.
- Navigation gain Ajusta el volumen de los anuncios de la navegación.
- Background music permite la escucha del audio cuando interviene un aviso de navegación.
- File address archivo ejecutable de navegación, seleccionar mobilnavigator.exe.



## NAVEGACION

En la primera activación de la cartografía iGO (opcional) seleccionar el archivo ejecutable mobilenavigator.exe en los ajustes.

- Acceder al menú ajustes del software.



## CONFIGURACION MODULO GPS



- Pasa a la segunda ventana



- Presionar GPS



- Presionar en la casilla de GPS ACTIVADO A continuación en DETECCIÓN AUTOMATICA



- Esperar la adquisición de los datos y presionar ok.
- Tomar como punto de referencia el manual iGO para las instrucciones sobre el software de navegación.



## VIDEO

- Presionar para entrar en el menú Video.
- Video input selecciona sistema entrada video: AUTO/PAL/NTSC/SECAM
- Rear camera configura la visión normal o tipo espejo (mirror) de la retro-cámara.
- Parking activa/desactiva la visión video en movimiento.
- Aspect ratio Selecciona formato video: 4:3-16:9.



## SOUND

- Presionar para entrar en el menú Sound.
- Subwoofer filter corte de frecuencia PASO BAJO para salida subwoofer 80/120/160 Hz.
- Subwoofer output activa/ desactiva salida.
- DRC activa/desactiva DRC.



## SEGURIDAD

- Presionar para entrar en el menú Security.
- Rating level configura el nivel de seguridad para la visión de las películas.
- Set password configura la password para el nivel de seguridad.
- Load factory vuelve a los ajustes de fábrica.



## FUNCIÓNES RADIO

- Con las teclas ◀◀ y ▶▶ en la radio o con el mando a distancia la unidad buscará automáticamente las emisoras.
- Para la búsqueda manual hacer deslizar el indicador de frecuencia.
- 📶 Selecciona Bandas Radio 3 FM - 2 AM.

### Memorizaciones emisoras.

- 📁 Presionar y seleccionar la memoria. Disponibilidad de 6 memorias por cada banda.
- Para re-llamar una emisora memorizada presionar la tecla correspondiente.
- 🔍 Escansión de todas las frecuencias.



## FUNCIÓNES RADIO

- **AF** Búsqueda de una frecuencia alternativa con informaciones de la emisora en la pantalla.
- **TA** Informaciones de tráfico.
- **PTY** Selecciona el tipo de programa musical.
- 📶 **LOC** Selecciona las emisoras locales o lejanas.
- 🔄 **ST** Transmisión estéreo.
- 📶 Ecualizador.

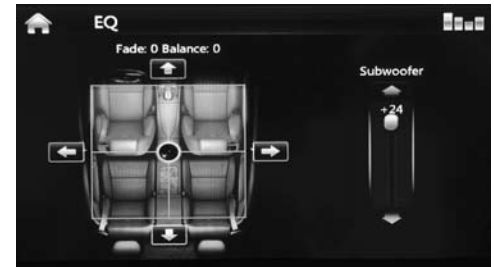

## ECUALIZADOR

- 🔄 Fader y subwoofer.
- ◀ User ▶ Selecciona EQ: FLAT/POP/CLASSIC JAZZ/VOCAL/DANCE/USER
- 🔄 Vuelve a los valores de fábrica.
- Ajusta FADER y BALANCE.
- Ajusta el nivel del SUBWOOFER.





## FUNCIONES VIDEO DVD

- 1/2 Menú siguiente.
- Zoom, aumenta y reduce la imagen.
- Canción precedente.
- Pausa y reproducción.
- Canción siguiente.
- Menú títulos.

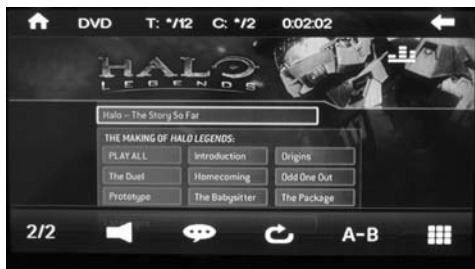

## FUNCIONES VIDEO DVD

- 2/2 Menú precedente.
- Idioma audio.
- Subtítulos.
- Repetición canción/capítulo/disco.
- **A-B** Repetición desde el punto A al punto B.
- Teclado para seleccionar capítulos.



## FUNCIÓNES VIDEO USB/SD CARD

Las primeras 5 funciones son igual al menú DVD

- Menú títulos.



## FUNCIÓNES VIDEO USB/SD CARD

Igual al menú DVD a parte la función

## REPRODUCCIÓN USB/SD CARD



### REPRODUCCIÓN MUSICA

- 🎵 Visualiza archivo de audio.
- 📁 Visualiza archivo de imagen.
- 📺 Visualiza archivo de video.
- ⬆️ Desplaza abajo.
- ⬆️ Muovi giù.
- 📄 Teclado para seleccionar la canción.



### REPRODUCCION MUSICA

- 🎲 Reproducción casual.
- 🔄 Repetir canción.
- ⏮️ Canción precedente.
- ⏸️ Pausa y reproducción.
- ⏭️ Canción siguiente.
- ■ Stop reproducción.



### REPRODUCCIÓN IMAGENES

- 🔍 Zoom, aumenta y reduce la imagen.
- 🔄 Rotación imagen.
- ⏮️ Canción precedente.
- ⏸️ Pausa y reproducción.
- ⏭️ Canción siguiente.
- ⌚ Velocidad reproducción imágenes NORMAL/FAST/LOW.



## EMPAREJAMIENTO TELEFONO

Es posible emparejar hasta 5 teléfonos.

- Activar la función bluetooth en el teléfono móvil y buscar nuevos dispositivos.
- Seleccionar **FW3307** en la lista de los dispositivos, introducir la password 0000 cuando sea solicitada. Una vez emparejado, aparecerá el nombre del telefono móvil.

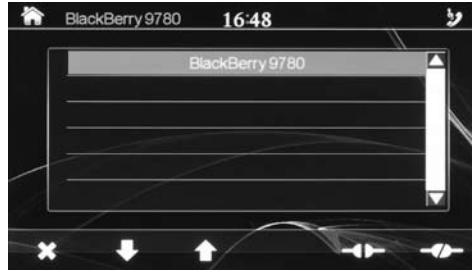

## DISPOSITIVOS EMPAREJADOS

- ✂ Presionar para desconectar el teléfono.
- ↔ Presionar para volver a conectar.
- ✕ Desconecta y cancela de la lista.







## LLAMAR DESDE LA PANTALLA

- Presionar uno de los iconos presentes en la pantalla para llamar desde uno de los listados.
  - ☎ Llamadas perdidas
  - ☎ Llamadas recibidas
  - ☎ Llamadas efectuadas
  - 📅 Agenda telefónica
    - Seleccionar el número y presionar ☎.
- Llamada mediante el teclado numérico.
  - Digitar el numero y presionar ☎.
- ← Cancela el último numero.
- C Cancela todos los números.



### RECIBIR UNA LLAMADA

Cuando recibimos una llamada, el VM033 pasa automáticamente en modo bluetooth.





-  Para contestar.
-  Para terminar o rechazar la llamada.
-  Para excluir el Manos libres.
-  Para activar o desactivar el micrófono.



### REPRODUCCION MUSICA BLUETOOTH

Si el teléfono conectado soporta el perfil A2DP es posible escuchar las canciones presentes en el móvil.

Si el dispositivo soporta AVRCP será posible controlar las canciones directamente desde la pantalla táctil.

-   Canción precedente/siguiente.
-   Inicia/interrumpe la reproducción.



### IPOD

Conectando el producto Apple mediante el cable en dotación, se visualiza automáticamente la ventana iPod. Elegir la propia música según las playlist y los álbumes mediante la pantalla táctil. Es compatible con toda la gama iPod e iPhone (3G-3GS-4-4S).

## **CARATTERISTICHE TECNICHE • TECHNICAL FEATURES • CARACTERISTIQUES TECHNIQUES TECHNISCHE DATEN • CARACTERISTICAS TECNICAS**

Monitor 6,95" Tft/Lcd Digitale Touch Screen  
Interfaccia Grafica Dinamica  
Display Alta Luminosità Risoluzione 800x480  
1 Slot Micro Sd Card per Navigazione  
1 Slot Micro Sd Card Multimedia Frontale 32 GB  
1 Porta Mini-Usb 2.0 su Frontale 32 GB  
1 Porta Usb 2.0 Posteriore 32 GB  
Comandi Volante Resistivi Integrati  
Predisposizione Comandi Al Volante Can-Bus  
Funzione Dual Zone Navigazione  
Sfondo Menù Personalizzabile  
Memoria Ultima Posizione  
Navigazione Gps Integrata (Mappa Optional)  
Vivavoce Bluetooth con Microfono Esterno  
(Supporto I-Phone4, A2DP, Gestione Rubrica)  
Ingresso IPOD con controllo playlist  
Equalizzatore  
Sintonizzatore Radio FM/AM RDS EON  
Potenza 4 X 45w Max  
4+1 Uscite Pre-Amplificate: Anteriore, Posteriore e Subwoofer  
1 Ingresso Audio/Video  
2 Uscite Video  
Ingresso Retrocamera con Attivazione Automatica  
Selezione Logo Auto  
Pip Riproduzione Video in Navigazione  
Riproduzione File Codifica Mpeg4  
Telecomando Multifunzione

*6,95" Tft/Lcd Touch Screen Digital Monitor  
Dynamic Graphic User Interface  
High Brightness and Res. Display (800x480)  
1 Slot Micro Sd Card for Navigation  
1 Slot Micro Sd Card Multimedia Front Input 8GB  
1 Slot Mini-Usb 2.0 Front Input 32GB  
1 Slot Usb 2.0 Rear Input 32GB  
Resistive Steering Wheel Command Built In  
Can-Bus Steering Wheel Command Inside  
Dual Zone  
Customizable Background  
Last Position Memory Function  
Built-In Navigation (Maps Optional)  
Handsfree with External Microphone  
(Iphone 4-A2dp Support-Phonebook Download)  
I-Pod with playlist control  
Equalizer  
RDS PLL Tuner with 18FM/12AM presets  
4 X 45w Max Power Output  
4.1 Channels Line-Out: Front, Rear And Subwoofer  
1 Av Input  
2 Video Outputs  
Automatic Rear Camera Input  
Setting Various Car Logo  
Pip  
Mpeg4 playback  
Full function wireless remote control*

Compatibile / *Compatible: DVD/DVD-R/DVD+R/DVD RW/DVD+RW/VCD/SVCD/CD/CD-R/CD-RW/MP3/MPEG-4/ XVID/WMA/JPG*





