



# DVD PLAYER



ITALIANO

ENGLISH

FRANÇAIS

DEUTSCH

ESPAÑOL

**MANUALE ISTRUZIONI • INSTRUCTIONS MANUAL**  
**NOTICE DE MONTAGE ET D'EMPLOI • GEBRAUCHSANWEISUNGEN**  
**MANUAL DE INSTRUCCIONES**

# **VM 071**

# COLLEGAMENTI • CONNECTIONS • CONNEXIONS • ANSCHLÜSSE • CONEXIONS

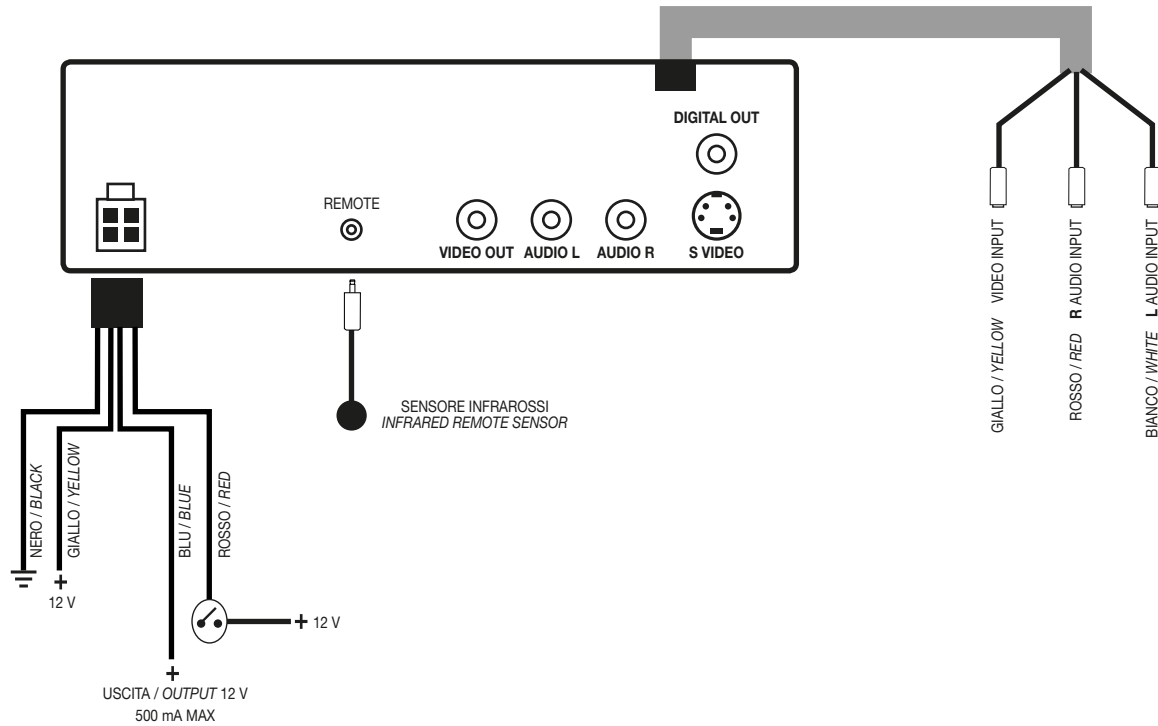

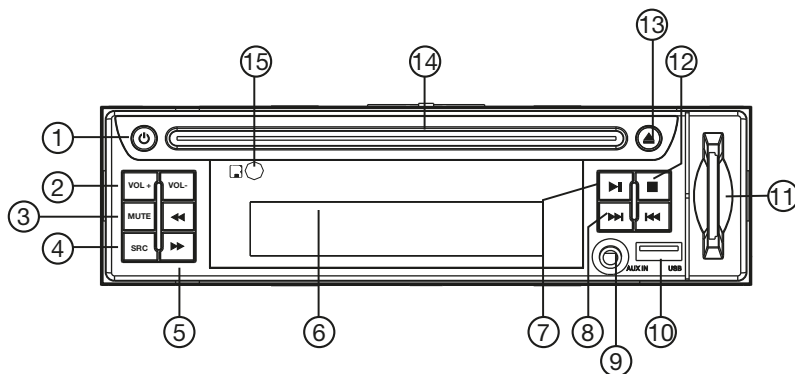

1. Accensione/Spengnimento ON/OFF
2. Regolazione volume
3. Mute Silenzia audio
4. SRC Sorgente
5. ◀▶ Avanti / Indietro veloce
6. Display
7. ▶◥ Play/Pause
8. ◀▶▶▶ Traccia precedente / successiva
9. Ingresso AUX-IN
10. Porta USB
11. Slot SD CARD
12. ■ Stop
13. Espulsione disco
14. Feritoia disco
15. Sensore IR

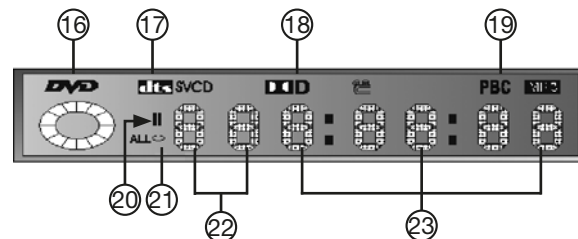

1. Switch ON/OFF
2. Volume adjustment
3. Mute
4. SRC Source
5. ◀▶▶▶ Fast Forward / Rewind
6. Display
7. ▶◥ Play/Pause
8. ◀▶▶▶ Previous / Next Track
9. AUX-IN input
10. USB-port
11. SD Card slot
12. ■ Stop
13. Disc eject
14. Disc slot
15. IR Sensor
16. Indicates the presence of the disc
17. Indicates DTS-recording
18. Indicates Dolby-recording
19. PBC-Symbol ON/OFF
20. Repeat Track/Chapter/Disc
21. Selection Chapter/Track
22. Reproduction lasting hours/minutes/seconds

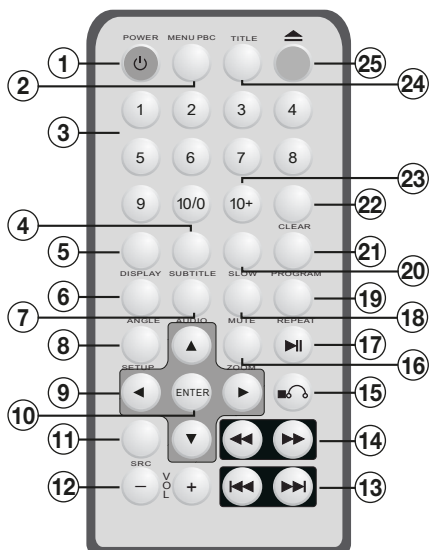

- |  |   |
|--|---|
| <ol style="list-style-type: none"> <li>1. <b>POWER</b> Accensione/Spegnimento</li> <li>2. <b>MENU DVD</b></li> <li>3. Tasti numerici</li> <li>4. <b>SUBTITLE</b> Sottotitoli <b>DVD</b></li> <li>5. <b>DISPLAY</b> Informazioni riproduzione</li> <li>6. <b>ANGLE</b> Angolo di visione</li> <li>7. <b>AUDIO</b> Informazioni audio e lingua <b>DVD</b></li> <li>8. <b>SETUP</b></li> <li>9. ◀▶▼▲ Tasti direzionali</li> <li>10. <b>ENTER</b> Conferma</li> <li>11. <b>SRC</b> Seleziona sorgente</li> <li>12. <b>VOL+ / VOL-</b> Regolazione volume</li> <li>13.  ◀◀▶▶  Traccia precedente o successiva</li> <li>14. ◀◀▶▶ Avanti / Indietro veloce</li> <li>15. ■ Stop riproduzione</li> <li>16. <b>ZOOM</b> Regolazione</li> <li>17. ▶   Riproduzione / Pausa</li> <li>18. <b>MUTE</b> Volume azzerato</li> <li>19. <b>REPEAT</b> Ripetizione traccia</li> <li>20. <b>SLOW</b> Riproduzione rallentata</li> <li>21. <b>NON ABILITATO</b></li> <li>22. <b>NON ABILITATO</b></li> <li>23. <b>10+</b> Avanza 10 tracce/Capitoli successivi</li> <li>24. <b>NON ABILITATO</b></li> <li>25. ▲ Espulsione disco</li> </ol> | <ol style="list-style-type: none"> <li>1. <b>POWER</b> Switch-on/Switch-off</li> <li>2. <b>DVD MENU</b></li> <li>3. <i>Number-keys</i></li> <li>4. <b>SUBTITLE DVD</b> Subtitles</li> <li>5. <b>DISPLAY</b> Playback info</li> <li>6. <b>ANGLE</b> Viewing Angle</li> <li>7. <b>AUDIO</b> Audio and language <b>DVD</b></li> <li>8. <b>SETUP</b></li> <li>9. ◀▶▼▲ <i>Direction Keys</i></li> <li>10. <b>ENTER</b> Confirmation</li> <li>11. <b>SRC</b> Select Source</li> <li>12. <b>VOL+ / VOL-</b></li> <li>13.  ◀◀▶▶  <i>Previous/Next track</i></li> <li>14. ◀◀▶▶ <i>Fast Forward/Backwards</i></li> <li>15. ■ <i>Stop playback</i></li> <li>16. <b>ZOOM</b></li> <li>17. ▶   <i>Playback/Pause</i></li> <li>18. <b>MUTE</b></li> <li>19. <b>REPEAT</b> Repeat track</li> <li>20. <b>SLOW</b> Slow playback</li> <li>21. <b>NOT AVAILABLE</b></li> <li>22. <b>NOT AVAILABLE</b></li> <li>23. <b>10+</b> Move 10 tracks/chapters forward</li> <li>24. <b>NOT AVAILABLE</b></li> <li>25. ▲ <i>Disc eject</i></li> </ol> |
|--|---|

|                 |              |          |
|-----------------|--------------|----------|
| <b>Language</b> | OSD Language | :English |
| <b>Video</b>    | Subtitle     | :English |
| <b>Audio</b>    | Audio        | :English |
|                 | DVD Menu     | :English |
| <b>Rating</b>   |              |          |
| <b>Misc</b>     |              |          |

Premere il tasto (SETUP) sul Telecomando.  
 Utilizzare i tasti ▼ / ▲ per posizionarsi sulla funzione desiderata e premere il tasto ENTER per confermare e SETUP per uscire.

*Press SETUP-key on the Remote-Control unit.  
 Use key ▼ / ▲ to move to the requested function. Now confirm selection by pressing ENTER. To quit, press SETUP-key.*



## LINGUA • LANGUAGE

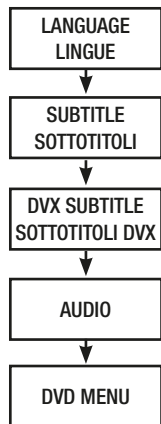

## VIDEO

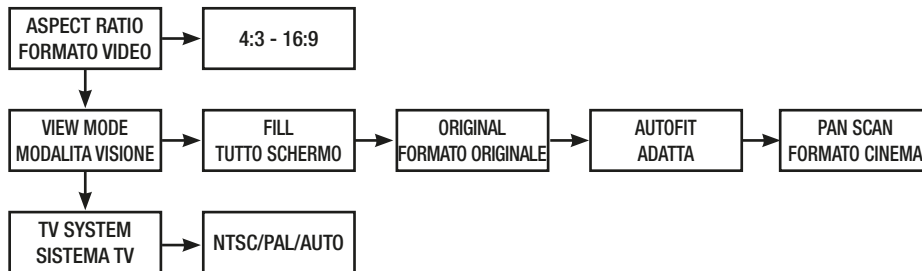

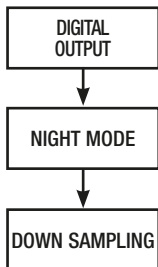

Prima impostare la password e successivamente regolare il livello di protezione.  
Password: impostazione di fabbrica 8888.

*At first, introduce Password. Then select the required Protection-Level.  
Password predetermined by Manufacturer: 8888.*

## IMPOSTAZIONI VARIE • VARIOUS SETTINGS • MISC

USE DEFAULT SETTING  
IMPOSTAZIONI DI FABBRICA

## USB/SD CARD

In assenza del disco, inserire il dispositivo USB/SD nell'apposita apertura. Il lettore cercherà automaticamente i file presenti sul supporto.

**Nota:** il funzionamento USB/SD è valido soltanto per la memoria volatile (flash). I formati compatibili sono: MP3, WMA, MPEG-4.

*Free from CDs, insert the USB/SD-support into the related Port. The Player will automatically search the files available on the related support.*

**Please note:** USB/SD-function works only referred to Flash-memory. Compatible Formats: MP3, WMA, MPEG-4.

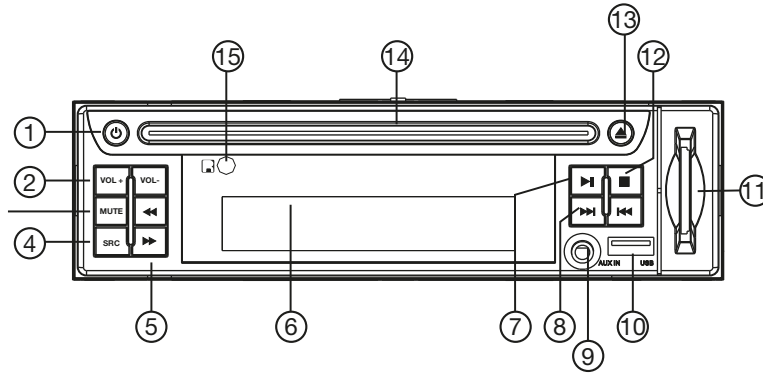

1. Allumage / extinction ON / OFF
2. Réglage du volume
3. Mute
4. SRC Source
5. << >> Avance / Retour rapide
6. Afficheur
7. >|| Play/Pause
8. << >> Trace Précédente / Successive
9. Entrée AUX-IN
10. Port USB
11. Slot SD Card
12. ■ Stop
13. Expulsion du CD
14. Fente du disque
15. Capteur IR

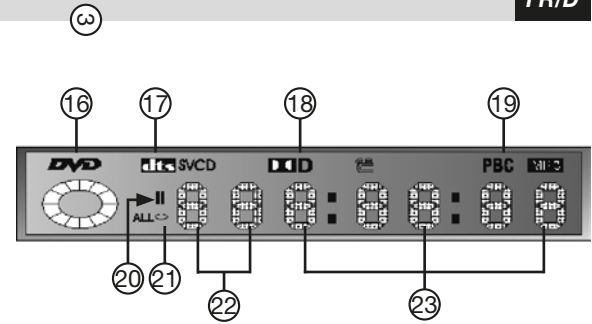

1. Ein-/Ausschalten ON/OFF
2. Lautstärke-Regelung
3. Stummschaltung (Mute)
4. SRC Quelle
5. << >> Schnell Vorwärts / Rückwärts
6. Display
7. >|| Play/Pause
8. << >> Stück davor / danach
9. AUX-IN-Eingang
10. USB-Öffnung
11. SD-Öffnung
12. ■ Stop
13. CD-Auswurf
14. CD-Öffnung
15. IR-Sensor
16. CD-Präsenz-Leuchte
17. DTS-Aufnahme im Gange
18. Dolby-Aufnahme im Gange
19. PBC-Symbol ON/OFF
20. Wiedergabe/Pause
21. Wiederhole Stück/Kapitel/CD
22. Kapitel/Stück
23. Wiedergabe-Dauer Stunden/Minuten/Sekunden

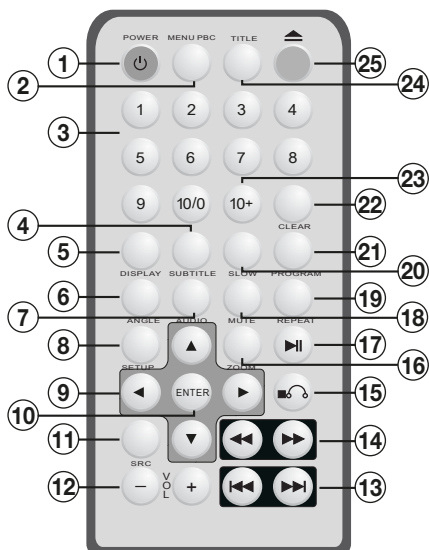

1. **POWER** Allumage / extinction
2. **MENU DVD**
3. Touches numériques
4. **SUBTITLE** Sous-titres **DVD**
5. **DISPLAY** Informations reproduction
6. **ANGLE** Angle de vision
7. **AUDIO** Renseignements et langue audio **DVD**
8. **SETUP**
9. ◀▶▼▲ Touches fléchées
10. **ENTER** Valide
11. **SRC** Sélectionne source
12. **VOL+ / VOL-** Réglages volume
13. |◀◀▶▶| Trace Précédente/Successive
14. ◀◀▶▶ Avance/Révient rapide
15. ■ Stop reproduction
16. **ZOOM** Réglage
17. ▶|| Reproduction/Pause
18. **MUTE** Volume mis à zéro
19. **REPEAT**: Répétition trace
20. **SLOW**: Reproduction ralentie
21. **Pas disponible**
22. **Pas disponible**
23. **10+ +** Avance de 10 traces / Chapitres successifs
24. **Pas disponible**
25. ▲ Expulsion CD

1. **POWER** Einschalten/Ausschalten
2. **MENU DVD**
3. Nummern-Tasten
4. **SUBTITLE DVD**-Untertitel
5. **DISPLAY** Wiedergabe-Infos
6. **ANGLE** Sichtwinkel
7. **AUDIO** Audio-Infos und DVD-Sprache
8. **SETUP**
9. ◀▶▼▲Pfeil-Tasten
10. **ENTER** = Bestätigung
11. **SRC**: Quellen-Wahl
12. **VOL+ / VOL-** Lautstärke-Regelung
13. |◀◀▶▶| Stück davor / danach
14. ◀◀▶▶ Schnell Vorwärts / Rückwärts
15. ■ Wiedergabe stoppen
16. **ZOOM** Einstellung
17. Wiedergabe/ Pause
18. **MUTE** Stummschaltung
19. **REPEAT** Stück wiederholen
20. **SLOW** Langsame Wiedergabe
21. **NICHT AKTIVIERT**
22. **NICHT AKTIVIERT**
23. **10+ 10** Stücke/Kapitel davor/danach
24. **NICHT AKTIVIERT**
25. ▲ CD-Auswurf



|                 |              |          |
|-----------------|--------------|----------|
| <b>Language</b> | OSD Language | :English |
|                 | Subtitle     | :English |
| <b>Video</b>    | Audio        | :English |
| <b>Audio</b>    | DVD Menu     | :English |
| <b>Rating</b>   |              |          |
| <b>Misc</b>     |              |          |

Appuyer la touche (SETUP) sur la télécommande  
 Se servir des touches ▼ / ▲ pour se placer sur la  
 fonction désirée et appuyer la touche ENTER pour  
 confirmer et SETUP pour sortir.

SET-UP-Taste auf der Fernbedienung drücken  
 Mit den Tasten ▼ / ▲ auf die gewünschte Funktion  
 gehen. Um die Wahl zu bestätigen, ENTER drücken.  
 Dann SETUP drücken, um Stellung wieder zu verlassen.

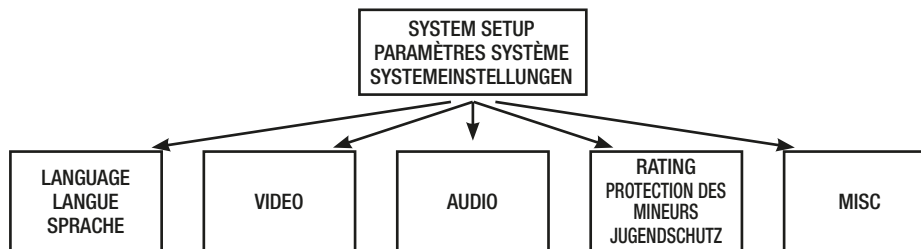

## LANGUE • SPRACHE

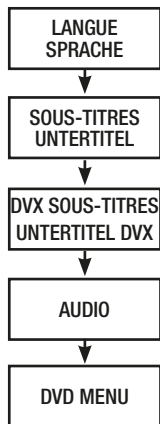

## VIDEO

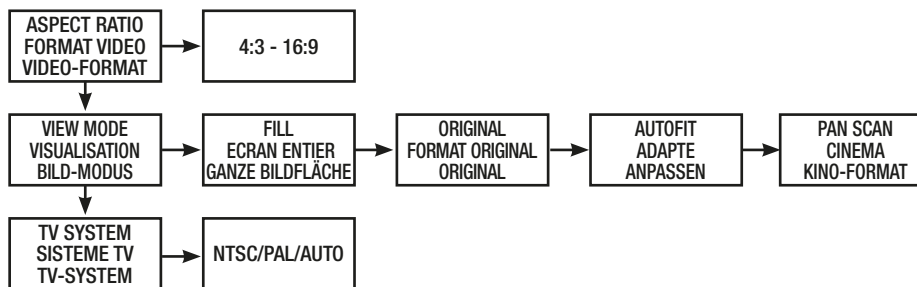

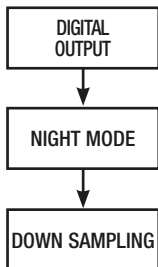

*Tout d'abord régler le mot de passe et successivement le niveau de protection  
Mot de passe: réglage d'origine 8888*

*Erst Passwort eingeben. Dann die gewünschte Schutz-Stufe eingeben.  
Vorgegebenes Hersteller-Passwort: 8888.*

## RÉGLAGES DIVERS. MISC • VERSCHIEDENE EINSTELLUNGEN

USE DEFAULT SETTING

## USB/SD-CARTE • USB-SD-KARTE

*Sans CD dans l'appareil, introduire le support USB/SD dans l'ouverture prévue. Le Lecteur cherchera automatiquement les Fichiers présents sur le support en question.*

**Note:** *le fonctionnement USB/SD est assuré uniquement pour la mémoire volatile (Flash).*

*CD aus dem Gerät entfernen. USB/SD in die vorgesehene Öffnung eingeben. Der Player wird nun automatisch die auf USB bzw. SD eingespeicherten Dateien suchen.*

**Wichtig:** *der USB/SD-Betrieb funktioniert nur begrenzt auf den Volatil-Speicher (Flash memory).*

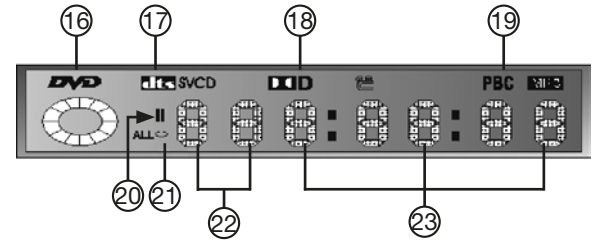
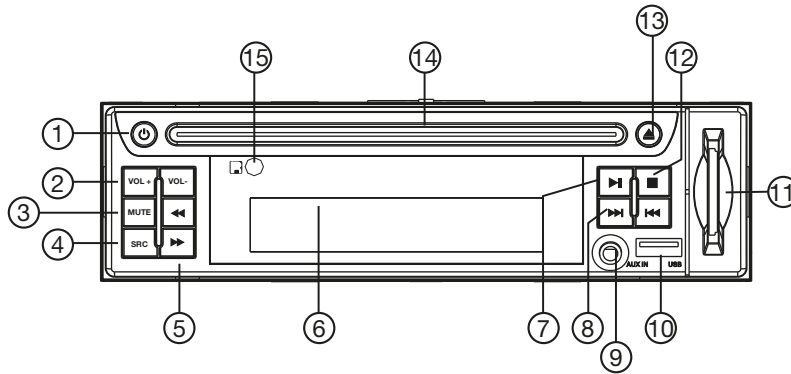

1. Expulsión disco
2. Ajuste del volumen
3. MUTE Volumen 0
4. SRC Selecciona fuente
5. << >> Avanzar/Retroceder rápido
6. Display
7. >>|| Reproducción / Pausa
8. << >> Pista precedente / siguiente
9. AUX-IN
10. Puerto USB
11. Ranura SD Tarjeta de memoria
12. ■ Stop
13. ▲ Expulsión disco
14. Ranura disco
15. Sensor IR
16. Indica la presencia del disco
17. Indicación grabación DTS
18. Indicación grabación Dolby
19. Símbolo PBC ON/OFF
20. Reproducción/Pausa
21. Repetición Pista/Capítulo/Disco
22. Selección Capítulo/ Canción
23. Tiempo Reproducción hora/minutos/segundos

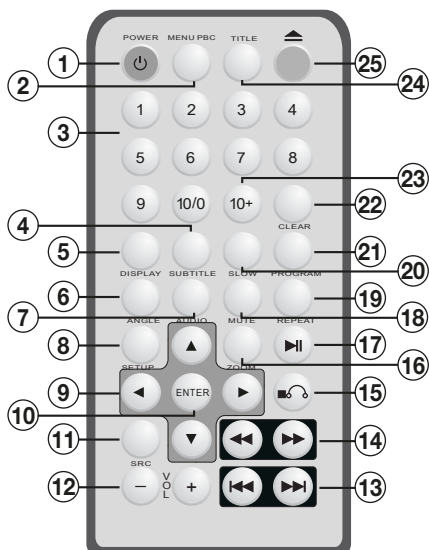

1. **POWER** Encendido/Apagado
2. **MENU DVD**
3. Teclas numéricas
4. **SUBTITLE** Subtítulos **DVD**
5. **DISPLAY** Información reproducción
6. **ANGLE** Ángulo de visión
7. **AUDIO** Información y el idioma de audio **DVD**
8. **SETUP**
9. ◀▶▼▲ Teclas de flecha
10. **ENTER** = Confirmar
11. **SRC** Selecciona fuente
12. **VOL+ / VOL-** Ajuste del volumen
13. |◀◀▶▶| Pista Precedente/Siguiente
14. ◀◀ ▶▶ Avanzar/Retroceder rápido
15. ■ Stop reproducción
16. **ZOOM** Ajuste
17. ▶|| Reproducción / Pausa
18. **MUTE** Volumen 0
19. **REPEAT** = Repetición Pista
20. **SLOW** = Reproducción ralentizada
21. **No habil**
22. **No habil**
23. 10+ Adelanta de 10 pistas /Capítulos sucesivos
24. **No habil**
25. ▲ Expulsión disco

|                 |              |          |
|-----------------|--------------|----------|
| <b>Language</b> | OSD Language | :English |
|                 | Subtitle     | :English |
| <b>Video</b>    | Audio        | :English |
| <b>Audio</b>    | DVD Menu     | :English |
| <b>Rating</b>   |              |          |
| <b>Misc</b>     |              |          |

Presionar la tecla (SETUP) en el mando a distancia.  
 Utilizar las teclas ▼ / ▲ para posicionarse en la función deseada y presionar la tecla ENTER para confirmar SETUP para salir.

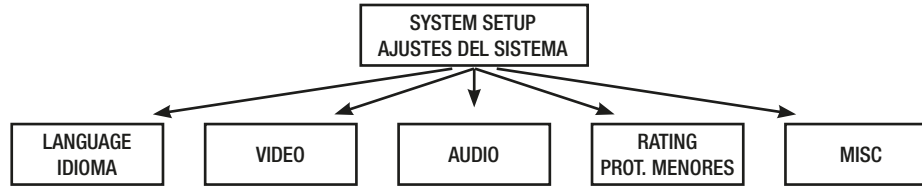

## IDIOMA

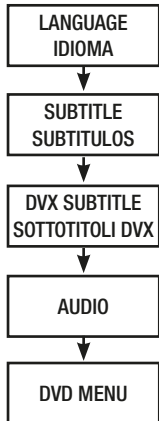

## VIDEO

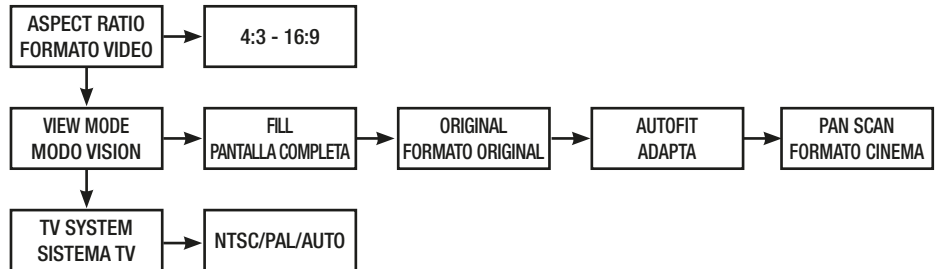

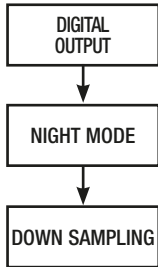

*Antes ajustar la password y sucesivamente ajustar el nivel de protección.  
Password: ajuste de fábrica n. 8888.*

## AJUSTES VARIOS • MISC

USE DEFAULT SETTING

## USB/SD CARD

*En ausencia del disco, introducir el dispositivo USB/SD en el específico puerto o correspondiente ranura. El reproductor buscará automáticamente los archivos presentes en el soporte.*

**Nota:** el funcionamiento USB/SD es válido solo para la memoria volátil (flash). Los formatos compatibles son: MP3, WMA, MPEG-4.

## CARATTERISTICHE TECNICHE • TECHNICAL SPECIFICATIONS • CARACTERISTIQUES TECHNIQUES TECHNISCHE DATEN • CARACTERISTICAS TECNICAS

|   |   |                              |
|---|---|------------------------------|
| • <b>Sistema colore</b>                                     | Color system                                      | <b>NTSC/PAL</b>              |
| • <b>Formati visualizzazione</b>                            | Conforming format to                              | <b>16:9 - 4:3 letter box</b> |
| • <b>Visualizzazione DVD multiangolo</b>                    | MultiAngle DVD vision                             |                              |
| • <b>Funzioni visibili a display</b>                        | On Screen display functions                       | <b>OSD</b>                   |
| • <b>Menù, Sottotitoli e Audio in lingue diverse su DVD</b> | Multiple Language Menu, Subtitle and Audio on DVD |                              |
| • <b>Memorizzazione dell'ultima posizione</b>               | Last position memory function                     |                              |
| • <b>6 velocità di ricerca</b>                              | 6 Speed Scan                                      |                              |
| • <b>Meccanica anti-urto</b>                                | Anti shock housing                                |                              |
| • <b>Protezione elettronica contro gli urti</b>             | Electronic shock protection system                |                              |
| • <b>1 Ingresso aux-in posteriore</b>                       | 1 Rear aux-in input                               |                              |
| • <b>1 Uscita audio stereo</b>                              | 1 Stereo audio output                             |                              |
| • <b>2 Uscite video</b>                                     | 2 Video output                                    |                              |
| • <b>Ricevitore IR esterno</b>                              | External IR sensor                                |                              |
| • <b>Telecomando con tutte le funzioni</b>                  | Remote Control with full Functions range          |                              |

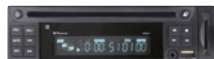

ISO

