

Technology *Art & Sound*  
Manufactured by  
**elettromeia** Italy

powered by



# H8 DSP

Digital Interface Processor

## USER'S MANUAL

rev 1.0

# Index

|   |    |
|---|----|
| <b>1. PRODUCT DESCRIPTION / SAFETY PRECAUTIONS</b>                        | 03 |
| <b>2. PACKAGING CONTENTS</b>  | 03 |
| <b>3. H8 DSP and DRC INSTALLATION</b>                                     | 04 |
| <b>4. CONNECTION PANELS – DESCRIPTION</b>                                 | 05 |
| 4.1 Multipolar connector  | 05 |
| 4.2 Input signals   | 06 |
| 4.3 Output signals  | 06 |
| 4.4 Inputs - remote control outputs and power supply                      | 07 |
| 4.5 Controls and settings   | 09 |
| <b>5. CONNECTIONS</b>   | 10 |
| 5.1 Power supply and remote turn on                                       | 10 |
| 5.2 How to turn the h8 dsp on / off                                       | 10 |
| 5.3 Personal computer and digital remote control (drc)                    | 11 |
| 5.4 High-level input signals  | 11 |
| 5.5 Low-level input signals   | 12 |
| 5.6 Optical in digital input  | 12 |
| 5.7 Output signals  | 13 |
| <b>6. HOW TO SETUP THE H8 DSP WITHOUT A PC</b>                            | 14 |
| 6.1 How to calibrate the master front-rear input sensitivity              | 14 |
| 6.2 Source de-equalization  | 15 |
| 6.3 Amplifiers sensitivity calibration                                    | 17 |
| 6.4 How to calibrate the aux in input sensitivities                       | 17 |
| <b>7. H8 DSP SOFTWARE AND DRIVERS INSTALLATION / UNINSTALLATION GUIDE</b> | 18 |
| 7.1 PC software installation guide  | 18 |
| 7.2 Drivers installation guide  | 20 |
| 7.3 H8 dsp software uninstall   | 21 |
| <b>8. H8 DSP INSTALLATION GUIDE USING A PC</b>                            | 22 |
| 8.1 Selecting the master (front / rear) inputs and outputs - target mode  | 22 |
| 8.2 Offline mode  | 29 |
| 8.3 Adjusting acoustic reproduction                                       | 30 |
| 8.4 Device info   | 30 |
| 8.5 "File" main menu  | 30 |
| 8.6 "Config" main menu  | 32 |
| 8.7 Selected input  | 33 |
| 8.8 Channel map   | 33 |
| 8.9 Select channel  | 33 |
| 8.10 Filter settings  | 34 |
| 8.11 Set distance and delay   | 36 |
| 8.12 Graphic equalizer  | 38 |
| 8.13 Output level   | 39 |
| 8.14 Memory   | 40 |
| <b>9. TROUBLESHOOTING</b>   | 41 |
| 9.1 Synchronization with a pc   | 41 |
| 9.2 Background noise  | 41 |
| 9.3 Firmware upgrade  | 42 |
| 9.4 Rescue mode   | 43 |
| <b>10. TECHNICAL SPECIFICATIONS</b>                                       | 44 |

## 1. PRODUCT DESCRIPTION / SAFETY PRECAUTIONS

The **H8 DSP** is a digital signal processor essential to maximize the acoustic performance of your car audio system. It consists of a 32-bit DSP processor and 24-bit AD and DA converters.

It can connect to any factory system, even in vehicles featuring an integrated audio processor, since, thanks to the de-equalization function, the **H8 DSP** will provide a linear signal.

It features 7 signal inputs: 4 Hi-Level, 1 Aux Stereo, 1 S/PDIF optical digital and It provides 8 PRE OUT.

Each output channel has a 31-band equalizer available. It also features a 66-frequency electronic crossover as well as BUTTERWORTH or LINKWITZ filters with 6-24 dB slopes and a digital time delay line. The user can select adjustments that allow him or her to interact with the **H8 DSP** through a remote control device called DRC.

- WARNING:** 1- To Install the software and set up the **H8 DSP** a PC provided with Windows XP, Windows Vista, Windows 7, Windows 8 or Windows 10 operating system, 1.5 GHz minimum processor speed, 1 GB RAM minimum memory and a graphics card with a minimum resolution of 1024 x 600 pixels is required.
- 2- Before connecting the **H8 DSP**, carefully read this manual. Improper connections may cause damage to the **H8 DSP** or to the speakers in the car audio system.

## 2. PACKAGING CONTENTS

- **H8 DSP** - Signal Interface Processor

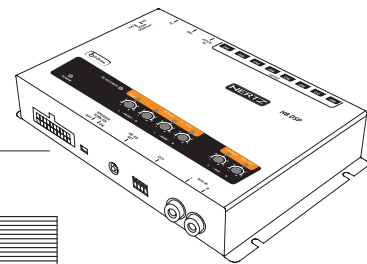

- Power supply cable / Remote / Inputs



- 3.0 m / 9,84 ft USB cable

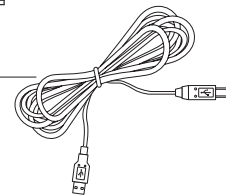

- 4 of 3.5 x 13 mm / 0,13" x 0,51" self-tapping, cross-head fixing screws



- CD ROM with:  
▪ H8 DSP Software  
▪ This advanced manual (.pdf format) Test tracks



- Quick start guide



## 3. H8 DSP AND DRC INSTALLATION

### External dimensions

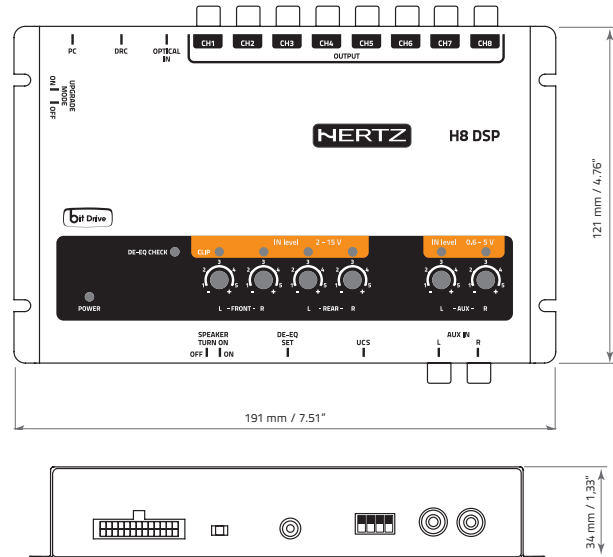

### Mounting dimensions

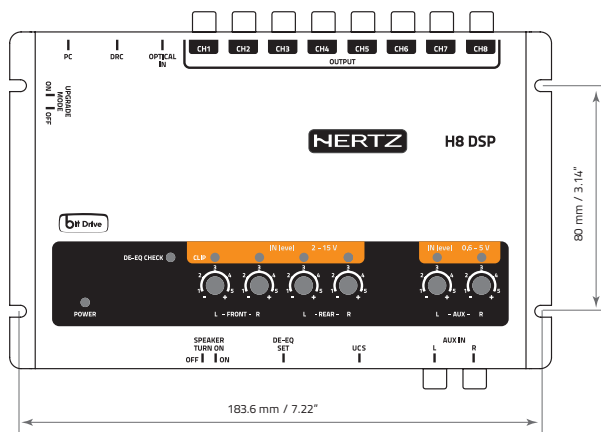

### How to install

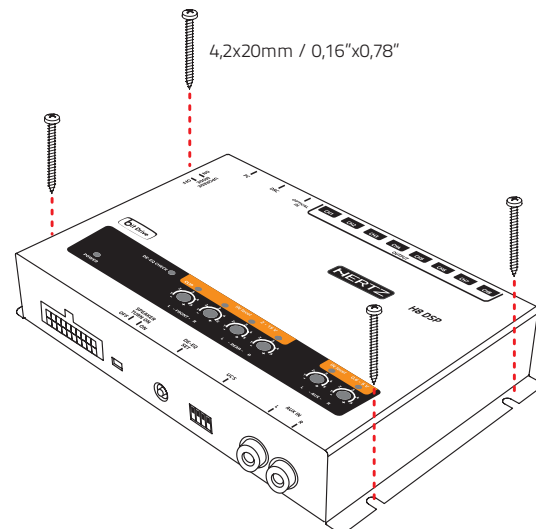



## 4. CONNECTION PANELS – DESCRIPTION

### 4.1 MULTIPOLAR CONNECTOR

The H8 DSP features a 20 multipolar interface for input signals, power supply and various control connections.

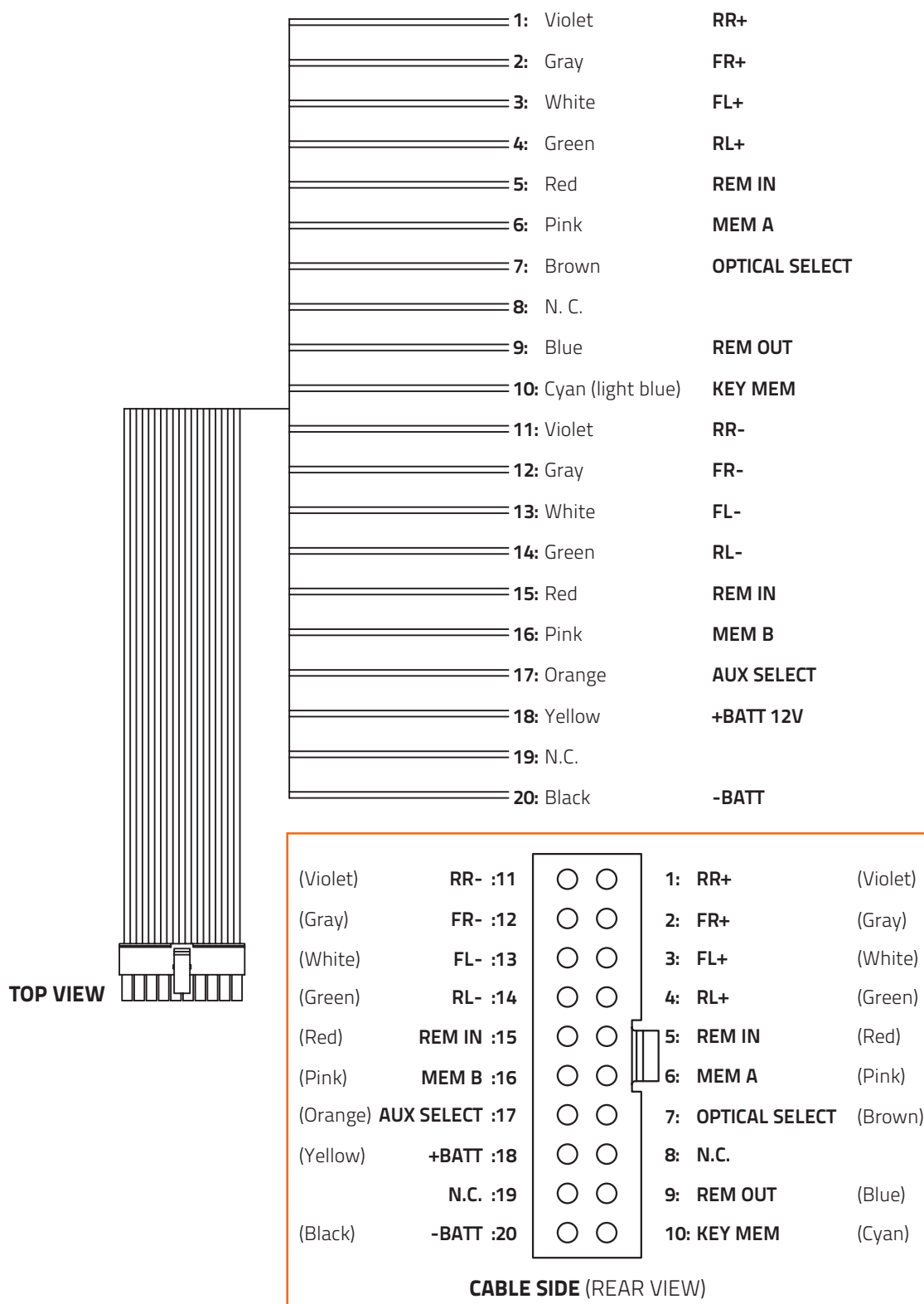

## 4.2 INPUT SIGNALS

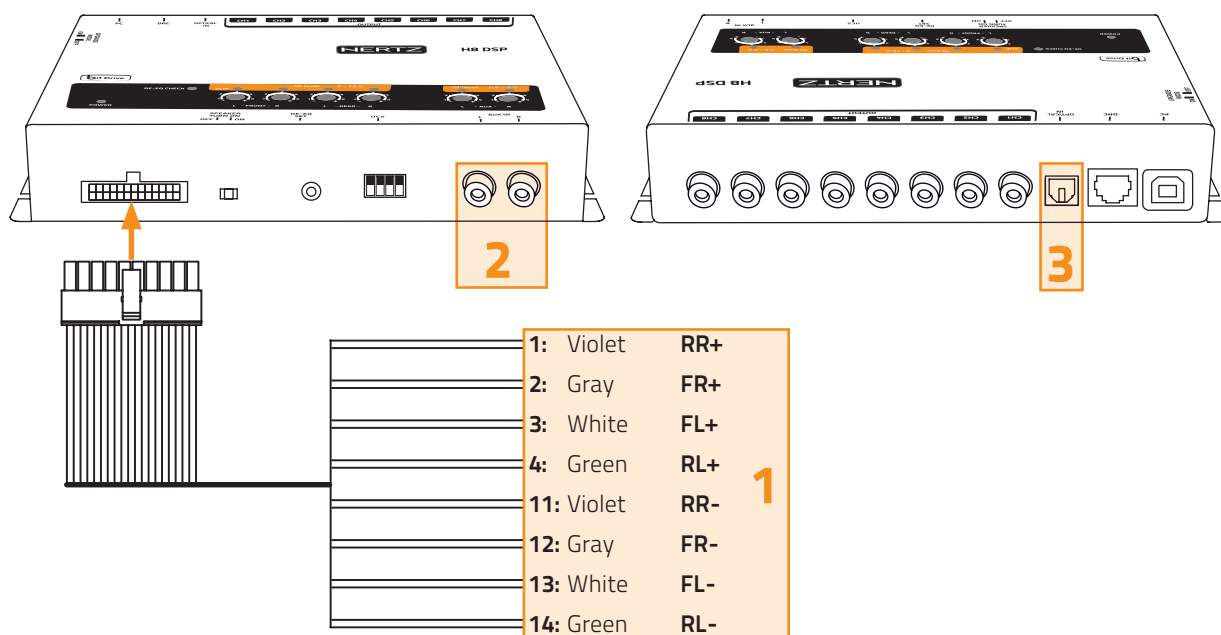

### 1. INPUTS; RL - FL - FR - RR. Hi-level MASTER inputs (SPEAKERS).

The **H8 DSP** features 4 HI-LEVEL signal inputs to connect amplified signal cables coming from the main analog source. Input sensitivity is adjustable from 2 to 15 V RMS.

### 2. AUX IN L - R; auxiliary low-level stereo input.

The **H8 DSP** features an auxiliary stereo input to connect an external source, mp3 player or other audio sources. Input sensitivity is adjustable from 0.6 to 5 V RMS.

**Remark:** If a low-level output source (PRE OUT) with output signal equal or higher than 2 V RMS is available, you can connect it to the high-level MASTER inputs (SPEAKERS). Sensitivity is increased by adjusting the IN LEVEL controls [\(see 8.1.9\)](#)

### 3. Optical digital S/PDIF input.

Connect an optical fiber cable with TOSLINK connector. The **H8 DSP** accepts PCM input signals up to 96kHz 24 bit sampling frequency [\(see 5.6\)](#).

## 4.3 OUTPUT SIGNALS

### 1. OUTPUTS CH1÷CH8;

Low-level analog signal.  
Connection for RCA cables dedicated to the system amplifiers.

SUB output is provided with CONSTANT BASS (when varying the fader, the SUB volume does not change) [\(see 5.7\)](#).

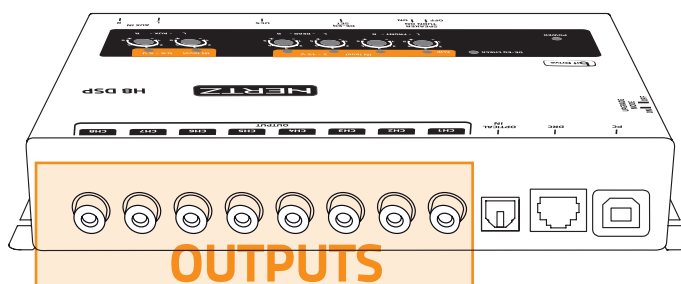

## 4.4 INPUTS – REMOTE CONTROL OUTPUTS AND POWER SUPPLY

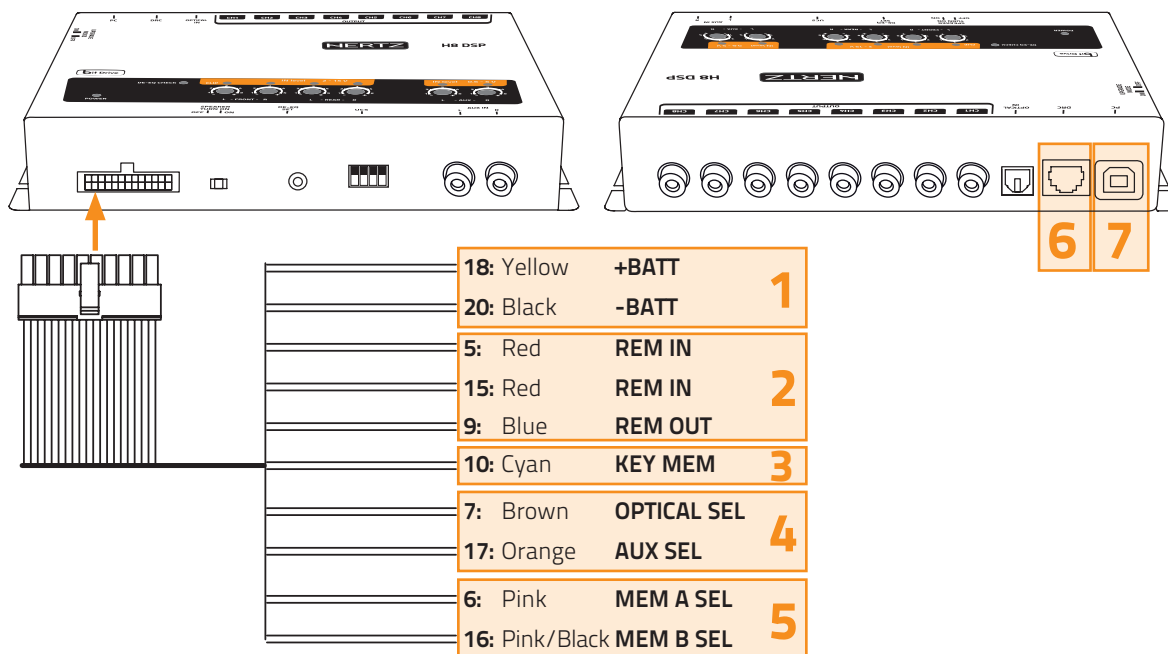

### 1. POWER SUPPLY.

**+BATT 12V:** 12V Power supply positive connection terminal.  
**-BATT:** Power supply negative connection terminal (GND).

**WARNING:** make sure the connection polarity is as indicated on the terminals. A misconnection may result in damage to the **H8 DSP**.

After connecting to power supply, wait at least 10 seconds before turning the **H8 DSP** on.

### 2. REMOTE IN-OUT.

**REM IN:** input for the processor remote turn on through the source Remote Out signal.

**REM OUT:** output to turn on other devices / amplifiers connected after the processor.

From the REMOTE-IN signal, the processor only takes 1 second to supply the signal to the **REM OUT** output.

The 130 mA output current capability can also drive an automotive relay (making sure it doesn't exceed 130 mA).

**WARNING:** the **H8 DSP** must be switched on before any amplifiers are turned on.

The system sources Remote Out must be connected to the product **REM IN**, and the product **REM OUT** is then to be connected to the Remote In of other devices / amplifiers.

### 3. KEY MEM:

To turn the processor on and off when the vehicle ignition is turned on / off.

**Remark:** This signal is memory-dependent: if the processor was turned off by a car sub-key connected to the KEY MEM, it will turn on again by turning the ignition key on. If the processor was turned off by a different method (e.g. DRC) while the KEY MEM was still active, it will not turn on again through the KEY MEM and you will have to turn it on by using either the DRC or REM IN.

### 4. OPTICAL SEL / AUX SEL:

Selection of the auxiliary OPTICAL or AUX inputs. The terminals can be set up with positive or negative selection. This function is active at +12V by setting up the UCS switch as shown in fig. 1, **while to obtain a –BATT (GROUND)** set up the switch as shown in fig. 2.

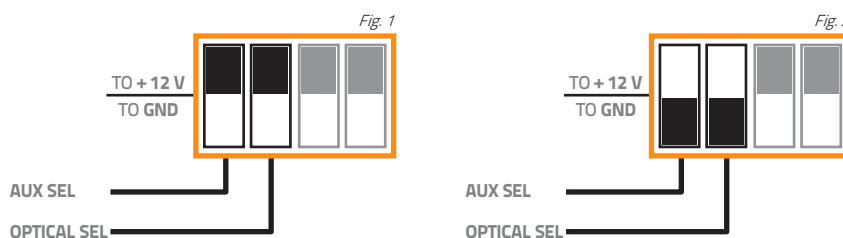

### 5. MEM A SEL / MEM B SEL:

Selection of the DSP "MEM A" or "MEM B" memories. The terminals can be set up with positive or negative selection. This function is active at +12V by setting up the UCS switch as shown in fig. 3, **while to obtain a –BATT (GROUND)** set up the switch as shown in fig. 4.

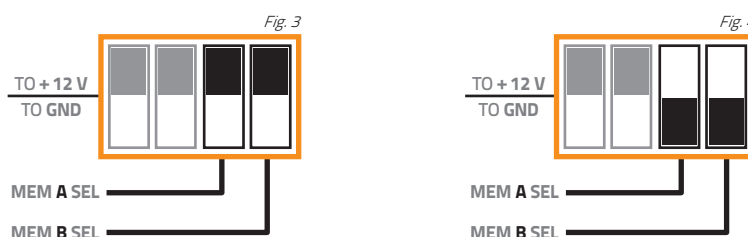

### 6. DRC:

DRC (Digital Remote Control) connection to configure the processor.

### 7. USB:

USB (type B) connection plug, to connect the processor to a PC and manage its functions through the H8 DSP software. The connection standard is USB 1.1 / 2.0 / 3.0 compatible.

## 4.5 CONTROLS AND SETTINGS

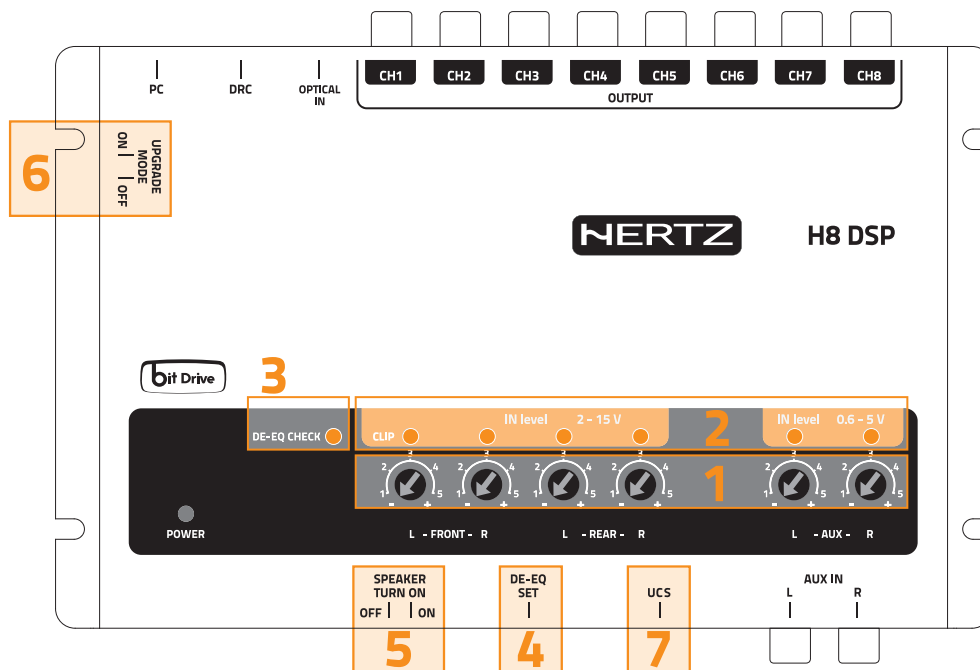

1. **IN level:** Input signals adjustments.  
By turning the knobs counter-clockwise, sensitivity decreases; by turning them clockwise, it increases. This setting is important for an optimal signal / noise ratio ([see 8.1 - 8.2](#)).
2. **CLIP:** Input clipping detector ([see 8.1.9](#)).  
If the LED lights up, it indicates clipping on the selected input.
3. **DE-EQ CHECK:** When lit, the meaning varies based on state ([see 6.2](#)).
  - **LED ON:** A de-equalization curve has been recorded.
  - **LED Flashing:** You are performing a de-equalization/analysis of the MASTER main input signal ([see 8.1.9](#)).
4. **DE-EQ SET:** Button to activate analysis or de-equalization functions during system calibration without using a PC ([see 6.2](#)).
5. **SPEAKER TURN ON:** Switch OFF to prevent turning the device on from the **MASTER** high-level main input ([see 4.2.1](#)). Switch ON allows turning the device on from the MASTER high-level main input ([see 5.4](#)).
6. **UPGRADE MODE:** Switch ON allows to update the product in **RESCUE MODE** ([see 9.4](#)) and the **POWER LED** will start flashing.
7. **UCS (User Control Set):** 4 selectors dip switch, enabling the AUX SEL, OPTICAL SEL, MEM A SEL, MEM B SEL terminals activation. The dip switch selection (see fig. 1) determines whether the terminals are active at +12 Volt or to -BATT (Ground). ([see 4.4.4 / 4.4.5](#)).

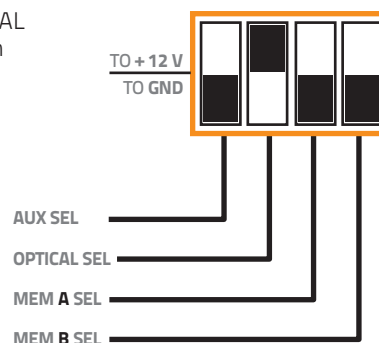

## 5 CONNECTIONS

### 5.1 POWER SUPPLY AND REMOTE TURN ON

**WARNING:** to power the device, use 1 mm<sup>2</sup> (16 AWG) cables.

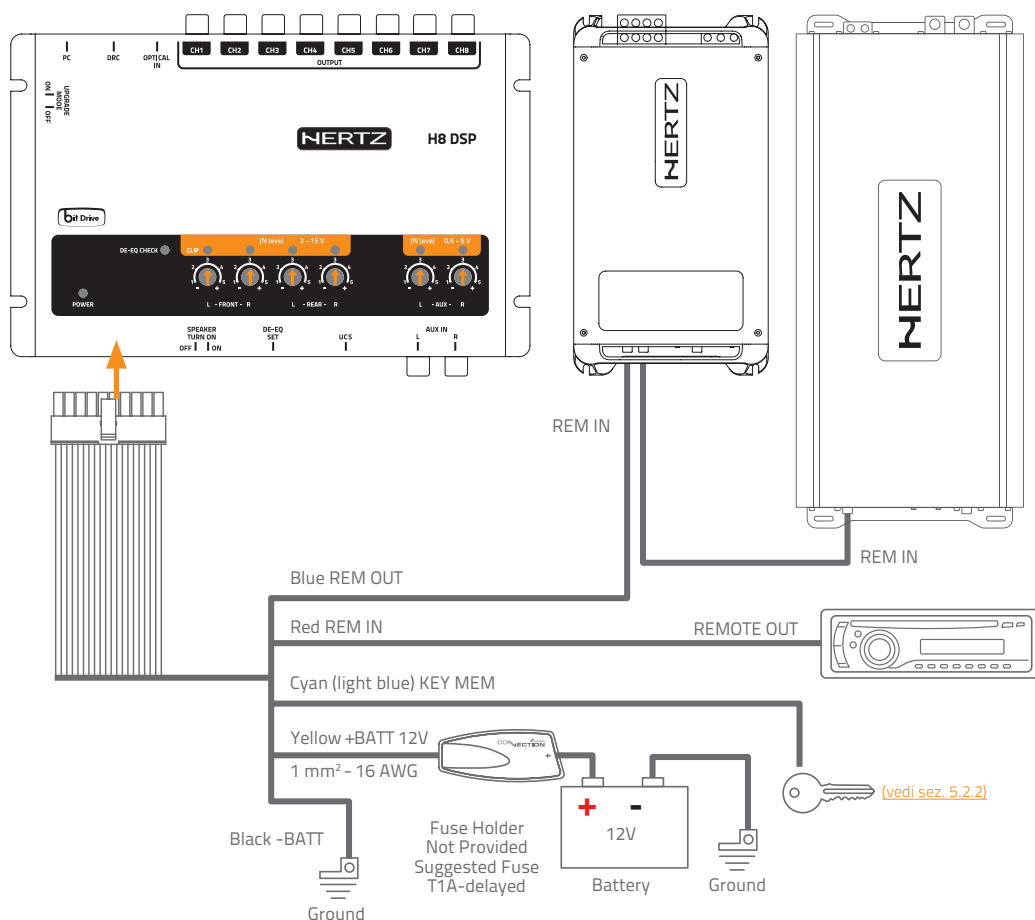

**Remark:** the H8 DSP is internally protected by a fuse-resistor soldered to its printed circuit board. To replace it contact a service center. Using an external fuse is recommended, though it is not required.

### 5.2 HOW TO TURN THE H8 DSP ON / OFF

The H8 DSP is on when the POWER ON LED lights up in white. It can be turned on / off in the following ways:

1. Press the DRC main "POWER" switch (to turn on). Keep the DRC main "POWER" switch pressed (to shut down). In this case, no other connections **Remote In / KEY MEM** are required, but they can coexist.
2. Connecting one of the **Remote In** plugs using a signal coming from a source. The **KEY MEM** connection is not required, but it can coexist.
3. Through the **KEY MEM**. This method is memory-dependent.
4. Through the **MASTER (INPUT FL)** input. The **AUTO TURN ON (ART)** function is enabled by connecting an amplified head unit output to the **INPUT FL** input channel. This function can be disabled by moving the **SPEAKER TURN ON** switch to **OFF** (see 4.5.5).

## 5.3 PERSONAL COMPUTER AND DIGITAL REMOTE CONTROL (DRC)

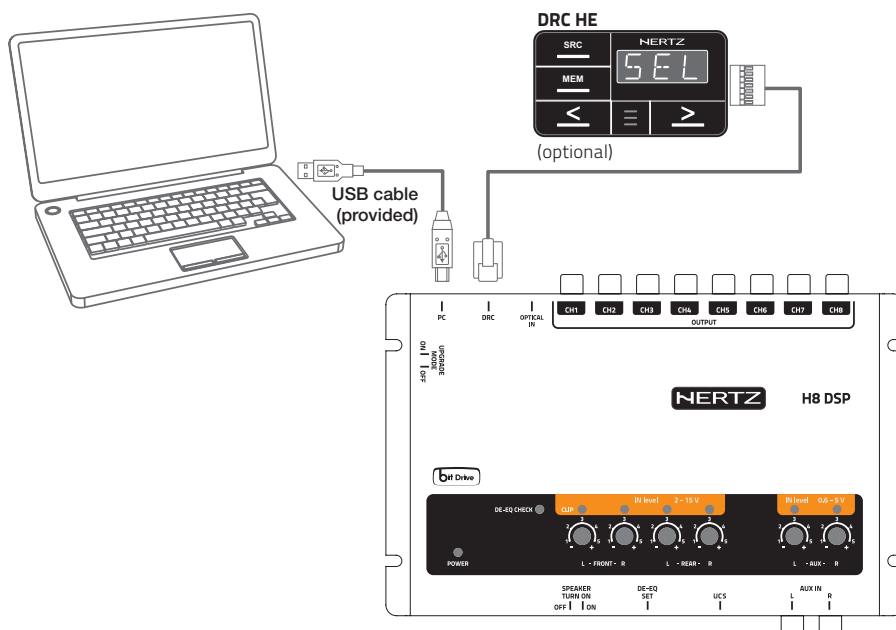

**WARNING:** if a DRC is not installed in the system the **H8 DSP** is set up with the volume adjustment to the maximum acoustic level. Connecting the processor without performing the required adjustments may lead the system to play at full power causing a strong acoustic noise and damaging the speakers.

## 5.4 HIGH-LEVEL INPUT SIGNALS

### 1. SPEAKERS IN HI-LEVEL STEREO FRONT+REAR [\(see 8.1\)](#)

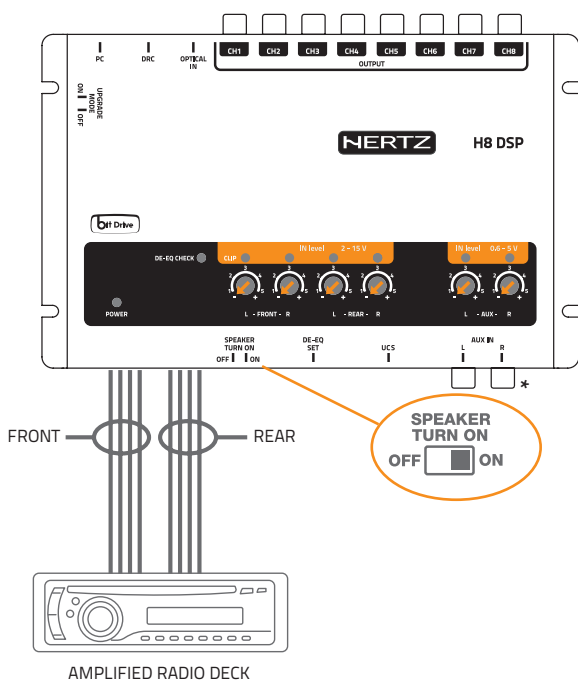

### 2. SPEAKERS IN HI-LEVEL MULTICHANNEL [\(see 8.2\)](#)

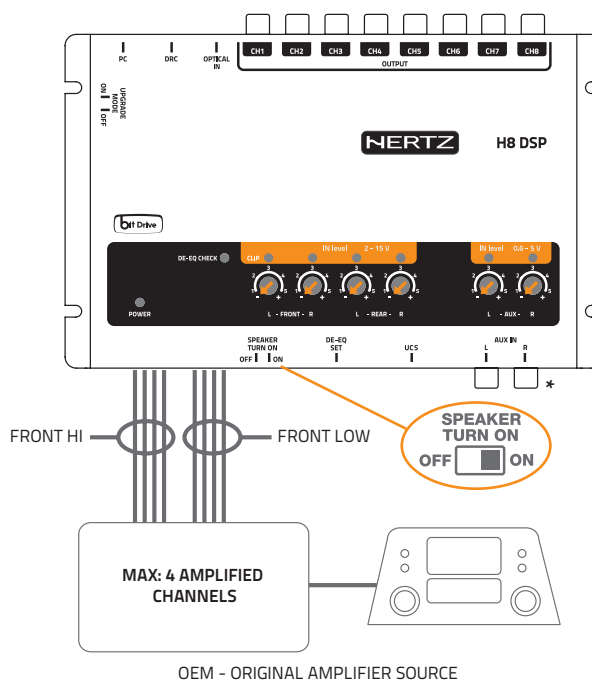

\*

To disable the Speaker Turn on function on the Front Left channel, move the indicated switch to the left to "OFF" position.



## 5.5 LOW-LEVEL INPUT SIGNALS

**AUX IN L/R:** Auxiliary analog stereo signal. Sensitivity is adjustable from 0.6 to 5 V RMS

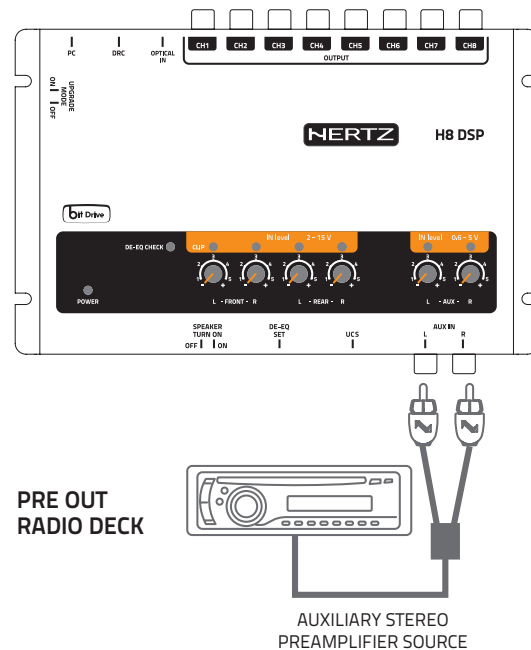
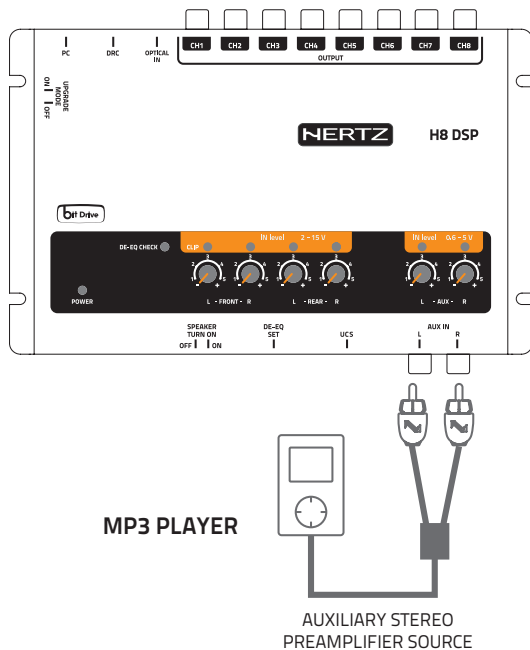

## 5.6 OPTICAL IN DIGITAL INPUT

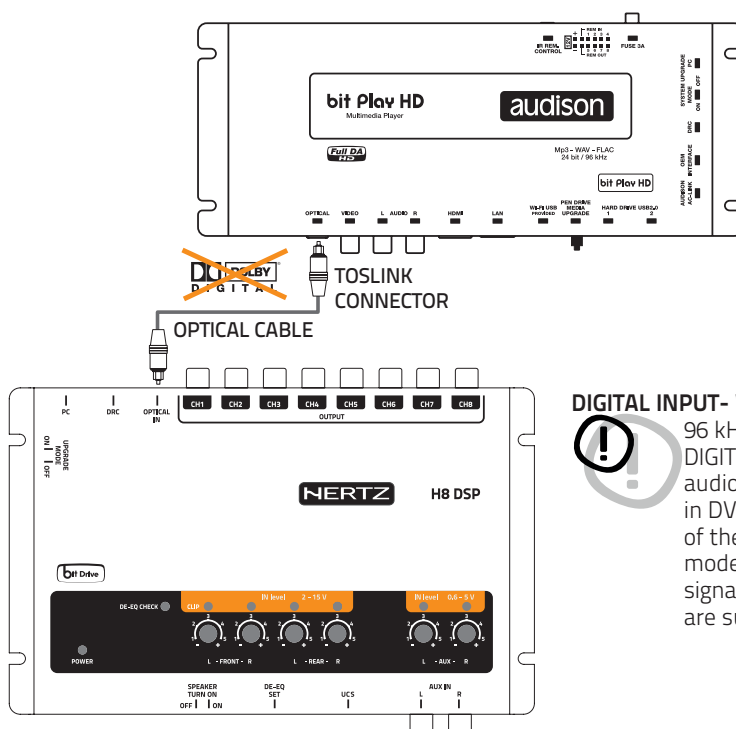

**DIGITAL INPUT- WARNING:** the digital input accepts up to 96 kHz / 24 bit stereo PCM signals. So DOLBY DIGITAL (AC3) multi-channel signals coming from audio/video sources (such as the audio of a film in DVD) or DTS can not be reproduced. The output of these devices will therefore be set in STEREO mode for the signal to be reproduced. If digital signals at frequency higher than 96kHz (Ex. 192 kHz) are supplied, the **H8 DSP** locks up.

## 5.7 OUTPUT SIGNALS

### OUTPUT TO PRE AMPLIFIERS' SYSTEM

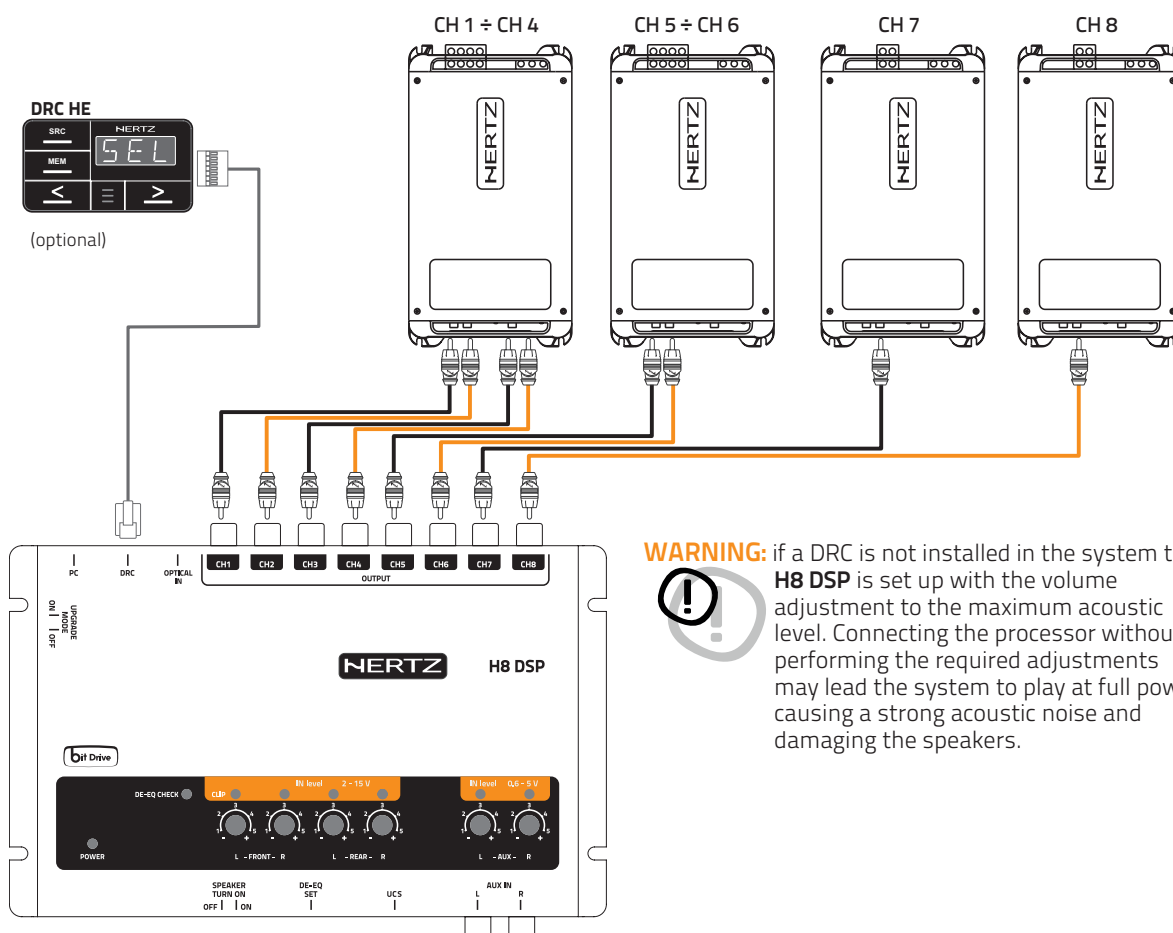

**WARNING:** if a DRC is not installed in the system the **H8 DSP** is set up with the volume adjustment to the maximum acoustic level. Connecting the processor without performing the required adjustments may lead the system to play at full power causing a strong acoustic noise and damaging the speakers.

| OUTPUT     | TYPE           | CUT FILTER | FILTER TYPE | CUT FREQUENCY           | TIME ALIGNMENT |
|------------|----------------|------------|-------------|-------------------------|----------------|
| <b>CH1</b> | Front Tw LEFT  | HI PASS    | LINKWITZ    | 3500Hz@12dB             | 0 cm           |
| <b>CH2</b> | Front Tw RIGHT | HI PASS    | LINKWITZ    | 3500Hz@12dB             | 0 cm           |
| <b>CH3</b> | Front WF LEFT  | BAND PASS  | LINKWITZ    | 80Hz@12dB/ 3500Hz@12dB  | 0 cm           |
| <b>CH4</b> | Front WF RIGHT | BAND PASS  | LINKWITZ    | 80Hz@12dB/ 3500Hz@12dB  | 0 cm           |
| <b>CH5</b> | Rear LEFT      | HI PASS    | LINKWITZ    | 80Hz@12dB               | 0 cm           |
| <b>CH6</b> | Rear RIGHT     | HI PASS    | LINKWITZ    | 80Hz@12dB               | 0 cm           |
| <b>CH7</b> | CENTER         | BAND PASS  | LINKWITZ    | 120Hz@12dB/ 5500Hz@12dB | 0 cm           |
| <b>CH8</b> | SUBWOOFER      | BAND PASS  | LINKWITZ    | 30Hz@12dB/ 80Hz@12dB    | 0 cm           |



## 6. HOW TO SETUP THE H8 DSP WITHOUT A PC

The **H8 DSP** can be used without a PC and in this case it will not be possible to use the sole the DE-EQ (de-equalization) function to eliminate any pre-existing equalization in the OEM audio system. The device will store the following default settings:

1. Front and Rear stereo broadband inputs;
2. AUX input ;
3. OPTICAL Input
4. 2 Way Front + Rear + Center + Subwoofer [\(Vedi 5.7\)](#)

**WARNING:** if a DRC is not installed in the system the **H8 DSP** is set up with the volume adjustment to the maximum acoustic level. Connecting the processor without performing the required adjustments may lead the system to play at full power causing a strong acoustic noise and damaging the speakers.



### 6.1 HOW TO CALIBRATE THE MASTER FRONT-REAR INPUT SENSITIVITY

1. **Connect the head unit speaker outputs to the H8 DSP high-level input [\(see 4.2-5.4\)](#). Before turning on the system, make sure the amplifiers RCA plugs are disconnected from the H8 DSP to avoid speaker damage during the calibration procedure.**

The input calibration procedure must be performed with the ignition turned on. In this case, the car voltage is about 14.0 Volts. The head unit will provide an undistorted output signal at higher volume.

2. Make sure that the IN Level knobs for the inputs used (L / R Front, L / R Rear, Aux IN L-R) are set to minimum sensitivity as in the figure (position -).

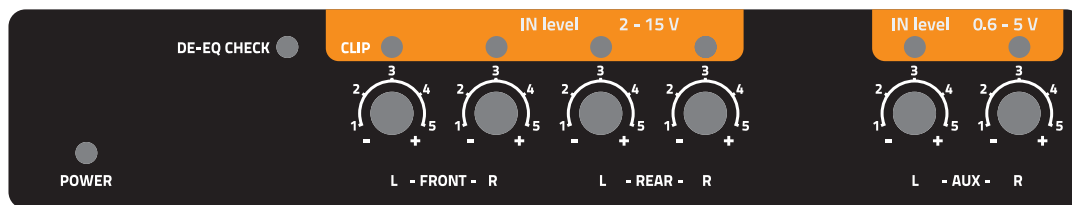

3. Turn on the device and play track 1 of the CD supplied with the **H8 DSP**.

- Set all tone controls to zero (flat).
- Set balance and fader to center.
- Adjust the head unit volume to the maximum undistorted output level.
- If the head unit features an adjustable equalizer, make sure that the controls are set to zero (flat).

**WARNING:** the head unit level must be elevated to the **maximum undistorted level**. If the head unit distortion level can not be tested in advance, adjust the volume to approximately 80% of its maximum. If the head unit output **level is set too low**, the device will produce ground noise (hissing sound) when playing music tracks. This is due to the low signal / noise ratio provided by the head unit to the **H8 DSP** input. If you have this problem after you calibrated the amplifiers sensitivity [\(see 8.1.21\)](#), increase the head unit volume and **repeat the H8 DSP calibration procedure** as detailed in the following paragraph 4.

#### Head unit input-level instrument check.

You will need an oscilloscope for this instrument check.

- Connect the head unit output to the oscilloscope.
- Play track 1 of the **H8 DSP** CD.
- Set tone, fader and balance controls and the equalizer (if any) to zero (flat).
- Turn on the car.
- Adjust the volume control so that the oscilloscope shows a sine wave with slightly cut peaks, as shown in the figure.
- Note down the volume used by the head unit. It must be left in this position for the following

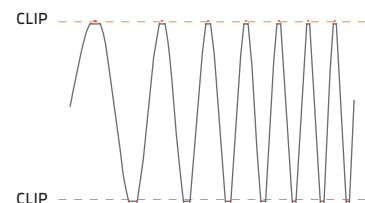

#### 4. MASTER inputs IN LEVEL calibration.

This procedure is delicate and requires utmost accuracy. Improper execution may invalidate the final acoustic results. **The H8 DSP outputs must be disconnected from the amplifiers.**

- While playing track 1 of the CD, turn the first knob towards the highest sensitivity (position +).
- When the orange LED lights up or flashes, stop turning and go back slightly until the LED turns off.

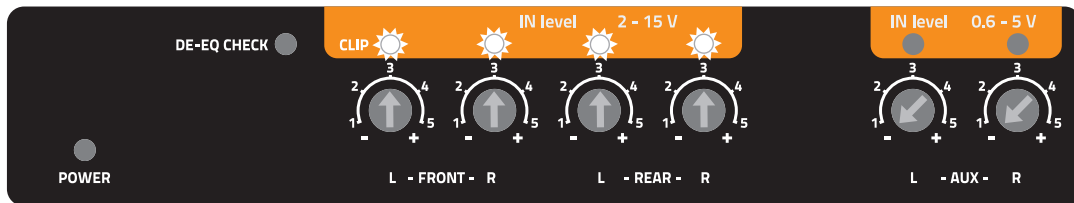

- It is normal for the LED to flash briefly; this indicates correct sensitivity calibration.
- Repeat the procedure for the other 3 Front / Rear knobs.
- Note down the calibration level used by the head unit volume control.

**WARNING:** Some OEM head units require a low load impedance to enable the outputs (usually the Rear section).

If during the calibration process the input signal level can't be adjusted, it may be necessary to connect in parallel a 47Ω - 3W resistor to the input cables of the channels showing the issue.



OEM audio systems are often provided with equalized outputs.

This means that the response curve is not flat and the difference between the highest and the lowest level can reach 6 dB. By calibrating the device so that the LED never lights up, the **H8 DSP** sensitivity may be suboptimal (low) and you may experience noise (whistle) on the speakers. A few quick LED flashes indicate only a small distortion when handling maximum peaks (very occasional) of music tracks.

If the source is not equalized, response is flat and the LEDs will always be on or always off. In this case, calibrating is easy because you will simply need to adjust the knobs so that the LEDs turn off just below the point they turn on.

## 6.2 SOURCE DE-EQUALIZATION

**Source de-equalization (De-Eq) is only required if the source is equalized.**

OEM sources often have a high output level (speaker output) with preset equalization that can not be deleted.

By replacing the OEM audio system (speakers and / or amplifiers), this equalization is harmful.

The **H8 DSP** features an automatic procedure to verify equalization and, if present, can eliminate it.

#### 1. Equalization analysis: source set up.

To run this procedure, follow the instructions below:

- Disconnect the **H8 DSP** RCA outputs (CH1÷CH8) if they are connected to the amplifiers.
- Play track 2 of the **H8 DSP** cd.
- Set all tone and equalizer controls to zero (0).
- Set balance and fader to center (0).
- Don't change or reset the volume of the input sensitivity calibration ([see 6.1.3](#)).

If the calibration volume is lost, to find it simply proceed again as described in paragraphs [6.1.1 - 6.1.3](#) and verify that the IN LEVEL LEDs flash occasionally.

## 2. De-equalization analysis: H8 DSP set up.

- Press the DE-EQ SET button and check the DE-EQ CHECK LED following the instructions in the image below.

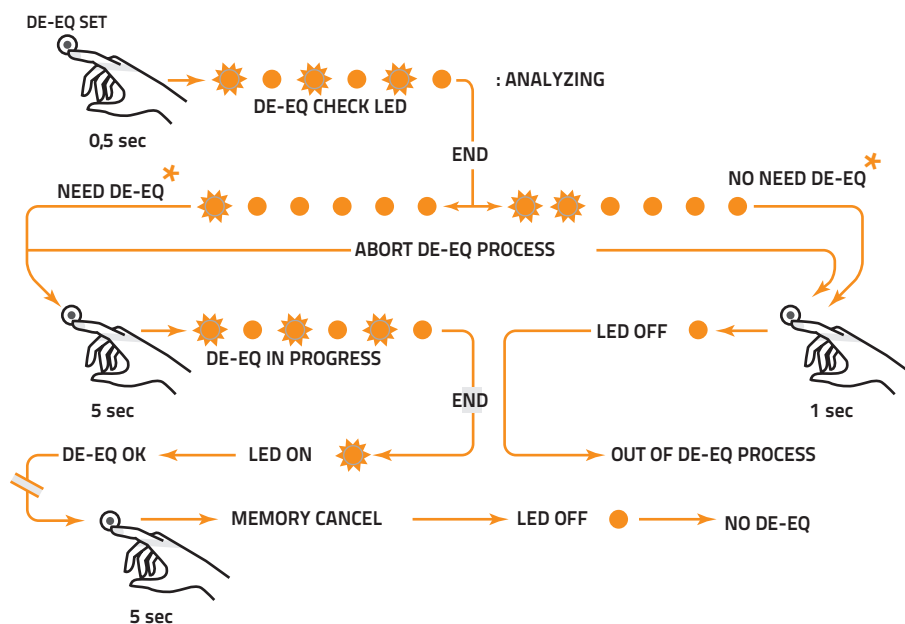
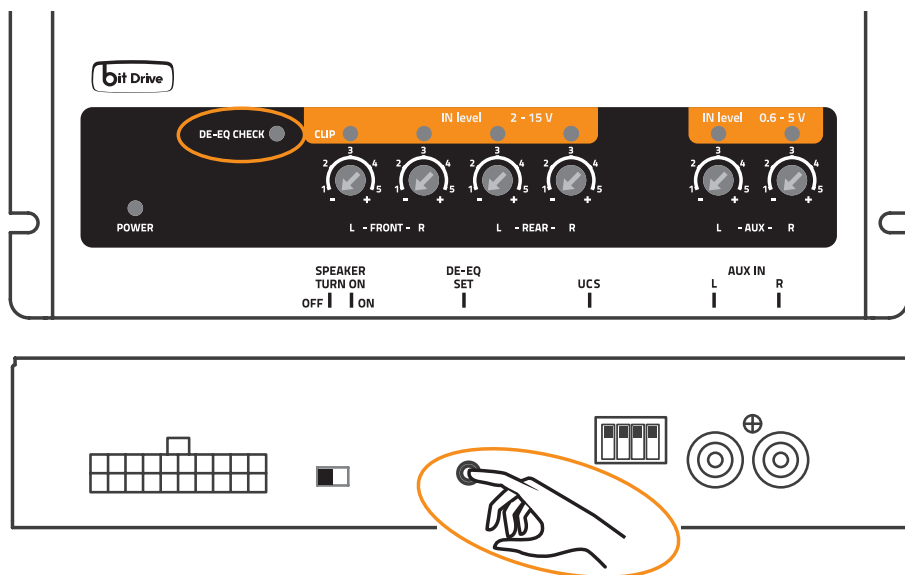

- The DE-EQ LED turns on to show that you recorded a de-equalization curve, otherwise it will be off.
- If the DE-EQ CHECK LED on the **H8 DSP** is on, you can run the de-equalization procedure again. The new data will erase the ones previously stored.

**\* Important:** Confirm or abort the de-equalization process within 5 minutes, otherwise the H8 DSP will automatically reset and turn off.

## 6.3 AMPLIFIERS SENSITIVITY CALIBRATION

Once the **H8 DSP** input calibration or de-equalization (if any) procedures are complete, you can calibrate the amplifiers sensitivity.

- Set the amplifiers crossover filters as desired and then connect them to the speakers.
- Connect the **H8 DSP** PRE outputs (CH1÷CH8) to the amplifiers inputs using high quality RCA cables.
- Set the amplifiers sensitivity of the various channels to about 4.0 Volts.

### 1. Amplifiers sensitivity calibration by listening.

- Place the head unit volume on the **H8 DSP** inputs sensitivity calibration level and play a highly dynamic track.
- Work on the amplifiers sensitivity controls slowly bringing them to higher sensitivity (less than 4.0 Volts). Once the first distortion symptoms show you should stop. This is easier if you work on one channel (stereo) at a time by disconnecting the other channels / amplifiers inputs.
- Once the amplifiers are calibrated, reconnect all the system channels and, if necessary, reduce the sensitivity (back to 4.0 Volts) of those channels that may have excessive volume.

### 2. Amplifiers sensitivity instrument calibration.

For instrument analysis, you will need an oscilloscope.

- Disconnect all speakers from the amplifiers if already connected.
- Play track 1 of the H8 DSP CD. All source controls must be flat (0). The volume control should be placed on the H8 DSP inputs calibration level.
- Connect the oscilloscope to an amplifier output channel. The video will display a sine wave with variable frequency (sweep).
- Turn the sensitivity control in both directions until the sine wave looks slightly cut at both ends.
- Repeat for each amplifier channel.
- Reconnect the speakers and insert a CD with a music track. Reduce the sensitivity (by turning the knob toward 4.0 Volts) of the channels that may have excessive volume.

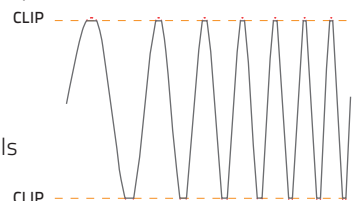

## 6.4 HOW TO CALIBRATE THE AUX IN INPUT SENSITIVITIES

Once the system is calibrated and fully working through the Front / Rear inputs, you can calibrate the AUX IN input.

**AUX IN:** To use this input install the DRC (optional), or activate it through the specific AUX SEL wire [\(see 4.4.4\)](#). [\(see 4.5.7\)](#).

- If a source with a CD player is connected to the AUX input, disconnect the **H8 DSP** outputs from the amplifiers and proceed as detailed in chapters [6.1.3 - 6.1.4](#).
- If the source to be connected to the AUX IN input has no CD player (e.g. mp3 player), you can calibrate by listening

- A** - Connect the **H8 DSP** RCA inputs (AUX IN) to the head unit output.
- B** - Play a music track.
- C** - Turn the IN Level / AUX knobs until the first distortion symptoms appear. Check if the IN Level / AUX LEDs flash occasionally.

## 7. H8 DSP SOFTWARE AND DRIVERS INSTALLATION / UNINSTALLATION GUIDE

### 7.1 PC SOFTWARE INSTALLATION GUIDE

1. Insert the "H8 DSP Setup CD 1.0" CD-ROM into the CD player of the PC you are going to use.
2. **Windows XP:** select My Computer from the Windows **START** menu;  
**Windows Vista:** select Computer from the Windows **START** menu;  
**Windows 7:** select Computer from the Windows **START** menu;  
**Windows 8/10:** click on the DESKTOP icon;

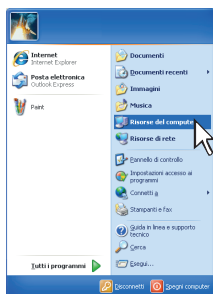

Windows XP

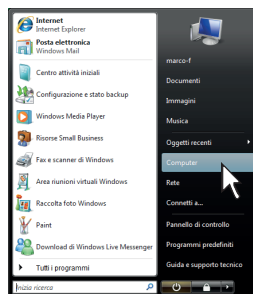

Windows Vista

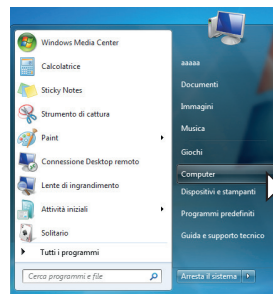

Windows 7



Windows 8 / 10

3. **Windows XP:** right-click the "H8 DSP Setup CD 1.0" CD icon and select **Explore**;  
**Windows Vista:** right-click the "H8 DSP Setup CD 1.0" CD icon and select **Explore**;  
**Windows 7:** right-click the "H8 DSP Setup CD 1.0" CD icon and select **Open**;  
**Windows 8/10:** double click on the Computer icon;

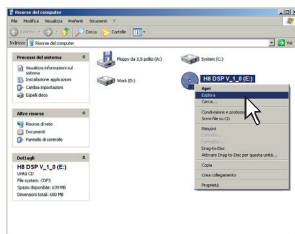

Windows XP

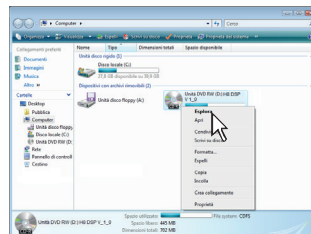

Windows Vista

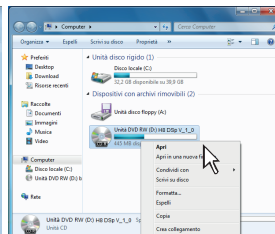

Windows 7



Windows 8 / 10

4. **Windows XP:** double click the **Setup** icon;  
**Windows Vista:** double click the **Setup** icon;  
**Windows 7:** double click the **Setup** icon;  
**Windows 8/10:** select the CD ROM drive and double click on **setup** icon.

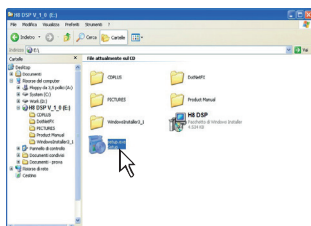

Windows XP

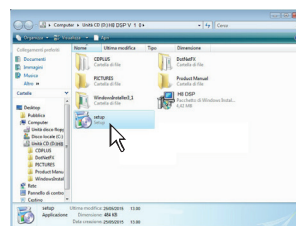

Windows Vista

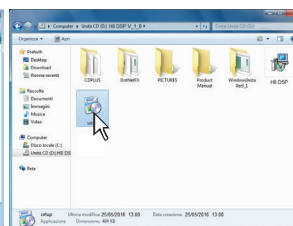

Windows 7

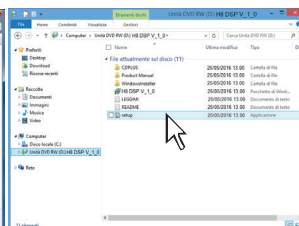

Windows 8 / 10



- Windows XP:** select **NEXT** to continue with the installation or **CANCEL** to interrupt it;  
**Windows Vista:** select **NEXT** to continue with the installation or **CANCEL** to interrupt it;  
**Windows 7:** select **NEXT** to continue with the installation or **CANCEL** to interrupt it;  
**Windows 8/10:** select **NEXT** to go on with the installation or **CANCEL** to interrupt it:

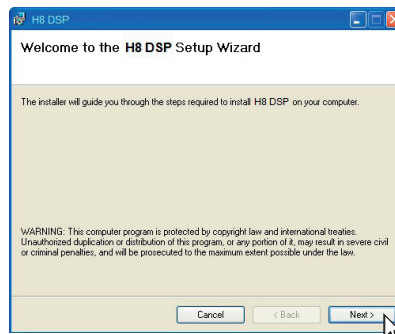

- Windows XP:** select **I Agree** and then **NEXT**;  
**Windows Vista:** select **I Agree** and then **NEXT**;  
**Windows 7:** select **I Agree** and then **NEXT**.  
**Windows 8/10:** select **I Agree** and then **NEXT**;



- Windows XP: select;**
  - **Everyone** if you have system administrator privileges, so that, once installed, the program can be used by anyone who uses that PC;
  - **Just me** if you want that, once installed, the program can only be used by yourself as a single system user. Then select **NEXT****Windows Vista: select**
  - **Everyone** if you have system administrator privileges, so that, once installed, the program can be used by anyone who uses that PC;
  - **Just me** if you want that, once installed, the program can only be used by yourself as a single system user. Then select **NEXT**.**Windows 7: select**
  - **Everyone** if you have system administrator privileges, so that, once installed, the program can be used by anyone who uses that PC;
  - **Just me** if you want that, once installed, the program can only be used by yourself as a single system user. Then select **NEXT**.**Windows 8/10: select**
  - **Everyone** if you have the system administrator privileges, so, once installed, the program can be used by anyone who uses that PC;
  - **Just me** if you want that, once installed, the program can only be used by yourself as single system user. Then select **NEXT**.

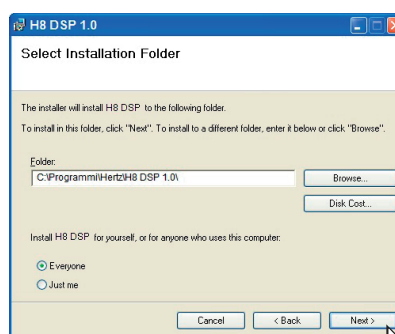

8. **Windows XP:** complete the installation procedure, then select **CLOSE** to exit the installation;  
**Windows Vista:** complete the installation procedure, then select **CLOSE** to exit the installation;  
**Windows 7:** complete the installation procedure, then select **CLOSE** to exit the installation;  
**Windows 8/10:** go on and complete the installation procedure, then select **CLOSE** to exit the installation;

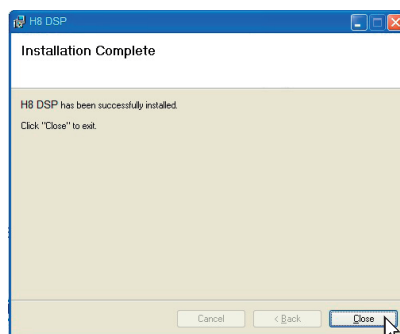

## 7.2 DRIVERS INSTALLATION GUIDE

1. Turn the **H8 DSP** on.
2. Connect the USB cable to the dedicated housing on the **H8 DSP** and to an available USB slot on the PC.

**WARNING:** When connecting a laptop PC via USB cable to the **H8 DSP** while the device is turned on, the laptop has to work with its own battery and stay disconnected from the mains adapter (external power supply). Once the connection between the laptop PC and the **H8 DSP** is established, you can immediately connect the computer, if necessary, to the mains adapter.

3. **Windows XP:** the PC will recognize the **H8 DSP** interface and will automatically install the driver;

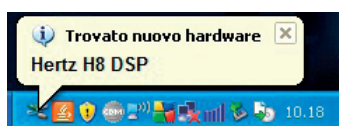

Windows XP

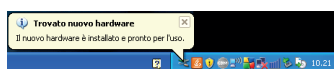

Windows XP

**Windows Vista:** the PC will recognize the **H8 DSP** interface and will automatically install the driver;

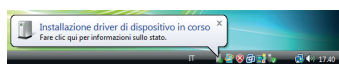

Windows Vista

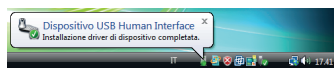

Windows Vista

**Windows 7/8/10:** the PC will recognize the **H8 DSP** interface and will automatically install the driver;

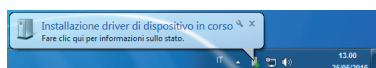

Windows 7 / 8 / 10



Windows 7 / 8 / 10

4. The peripheral device has been correctly installed and is ready for use.

**Remark:** The **H8 DSP** uses HID drivers already integrated in Windows. For this reason, they are not included in the CD and will always install automatically.

## 7.3 H8 DSP SOFTWARE UNINSTALL

### Procedure 1

To uninstall the **H8 DSP** PC software you can use the link listed on the following menu:  
Start / All Programs / **H8 DSP** / uninstall.

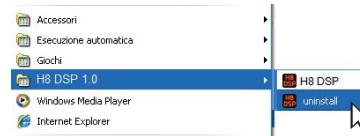

### Procedure 2

To uninstall the **H8 DSP** PC software you can also follow the standard procedure:  
Start / Control Panel / Applications Installation / **H8 DSP** / uninstall.





## 8. H8 DSP INSTALLATION GUIDE USING A PC.

To configure the **H8 DSP** inputs, analog (PRE) outputs, equalizations and time delays, the processor must be connected to a PC after calibrating the input levels. At that point, you need to have in mind the system you want to develop, since from this moment if you want to change any of the settings, you will have to go through the guided procedure all over again.

More specifically the guided procedure will request:

- Which kind of specialization the main inputs channels use. The guided procedure changes according to your selection.
- Which auxiliary inputs will be used (e.g. AUX and OPTICAL IN).
- Which kind of signals will be allocated to the different outputs (e.g. Front Left, Center or Subwoofer etc.).
- Which speakers you are using for your system (e.g. 2-way Front, Front / Rear, Sub etc.).
- If the system features passive crossovers to manage speaker groups (e.g. 2-way system with active mid-low).

During this procedure, you should disconnect the **H8 DSP** output RCA plugs to the amplifiers.



### 8.1 SELECTING THE MASTER (FRONT / REAR) INPUTS AND OUTPUTS - TARGET MODE

1. **Connect the head unit speaker outputs to the H8 DSP high-level input** (see 4.2).  
**Before turning on the system, make sure the amplifier's RCA plugs are disconnected from the H8 DSP to avoid speaker damage during the calibration procedure**

The input calibration procedure must be performed with the ignition turned on. In this case, the car voltage is about 14.0 volts. The head unit will provide an undistorted output signal at higher volume.

2. Make sure that the IN Level knobs for the inputs used (L / R Front, L / R Rear, Aux IN L-R) are set to minimum sensitivity as in the figure (position -).

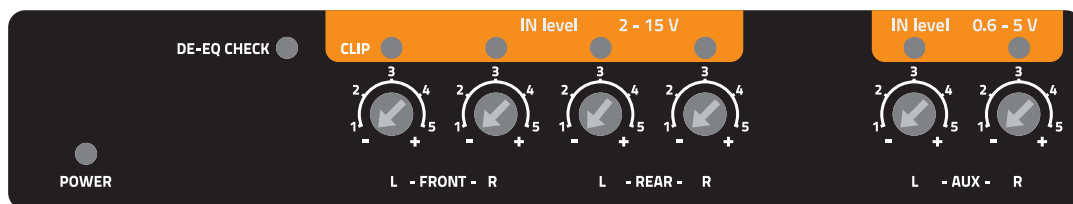

3. Turn on the **H8 DSP** and connect the USB cable to a PC. Start **H8 DSP** software by clicking the icon previously created on the PC desktop.

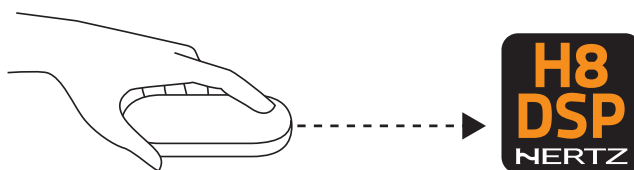

The first window is the start page where you need to choose among three operational modes:



- **CONNECT:** H8 DSP setup
- **OFFLINE H8 DSP:** demo mode H8 DSP
- **RESCUE MODE:** Firmware upgrade recovery

Select the **CONNECT** start mode on the drop-down menu.

4. If synchronization is successful, a dialog box will show the data exchange between processor and software. Wait a few seconds and, finally, confirm by selecting **OK**.



At this point you need to have in mind the system you want to develop beforehand, since from this moment if you want to change any of the settings you will have to go through the guided procedure all over again. More specifically the guided procedure will request:

- Which auxiliary inputs will be used (e.g. **AUX**, **OPTICAL**).
- Which kind of signals will be allocated to the main inputs (e.g. Front Left or Front Right etc.).
- Which speakers you are using for your system (e.g. 2-way Front + Sub etc.).
- If the system features passive crossovers managing speaker groups (e.g. 2-way system with active mid-low).

5. Click the **Config** menu and select **I/O Configuration Wizard**. Press **NEXT** to continue configuration. Press **CANCEL** to exit.

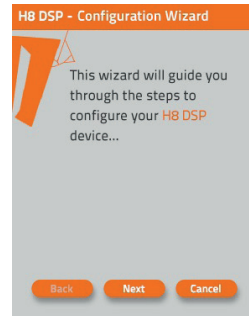

6. **Inputs Selection.**

Select the auxiliary inputs to be used between **AUX** and **OPTICAL**.

You can change this setting later on by selecting **Config / External Source** from the software main menu.

Press **BACK** to go back to the previous step.  
Press **NEXT** to go ahead with the setup procedure.  
Press **CANCEL** to exit the procedure.

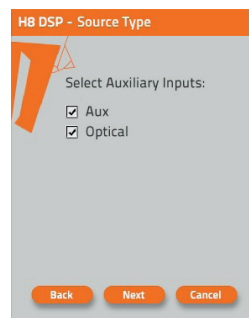

## 7. Master high-level main inputs configuration.

You can assign to any of the processor input channels a name corresponding to the signal coming from the source. The available names are: **FL** (Front Left Full); **FR** (Front Right Full); **RL** (Rear Left Full); **RR** (Rear Right Full); **FLTW** (Front Left Tweeter); **FRTW** (Front Right Tweeter); **FLW** (Front Left Woofer); **FRW** (Front Right Woofer); **Sub L** (Sub Left); **Sub R** (Sub Right).

The **H8 DSP** will use these names to reconstruct a full range signal coming from an OEM source with a dedicated multi-channel amplifier and assign the corresponding signal to the respective analog output.

Press **BACK** to go back to the previous step.  
Press **NEXT** to go ahead with the setup procedure.  
Press **CANCEL** to exit the procedure.

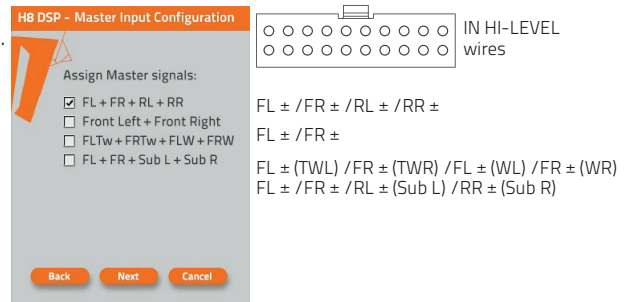

## 8. Source Setting.

- Turn on the system and play track 1 of the CD supplied with the **H8 DSP**.
- Set all tone controls to zero (flat).
- Set balance and fader to center.
- Adjust the head unit volume to the maximum undistorted output level.
- If the source features an adjustable equalizer, make sure that all controls are set to zero (flat).

Press **BACK** to go back to the previous step.  
Press **NEXT** to go ahead with the setup procedure.  
Press **CANCEL** to exit the procedure.



**WARNING:** the head unit level must be elevated to the **maximum undistorted level**. If the head unit distortion level can not be tested in advance, adjust the volume to approximately 80% of its maximum. If the head unit output **level is set too low**, the device will produce ground noise (hissing sound) when playing music tracks. This is due to the low signal / noise ratio provided by the **H8 DSP** input head unit. If you have this problem, after you **calibrate the amplifiers sensitivity** (see 8.1.21), increase the head unit volume and **repeat the H8 DSP calibration procedure** as detailed in the following chapter 9

### Head unit input-level instrument check

You will need an oscilloscope for this instrument check.

- Connect the head unit output to the oscilloscope.
- Play track 1 of the **H8 DSP** CD.
- Set tone, fader, balance controls and the equalizer (if any) to zero (flat).
- Turn on the car.
- Adjust the volume control so that the oscilloscope shows a sine wave with slightly cut peaks, as shown in the figure.
- Note down the volume used by the head unit. It must be left in this position for the following operations.

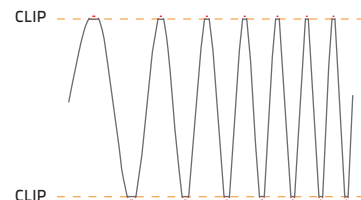

## 9. H8 DSP in Level inputs calibration.

This procedure is delicate and requires utmost accuracy. Improper execution may invalidate the final acoustic results. The **H8 DSP** outputs must be disconnected from the amplifiers

- While playing track 1 of the CD, turn the first knob towards the highest sensitivity (position +).
- When the orange LED lights up or flashes, stop turning and go back slightly until the LED turns off

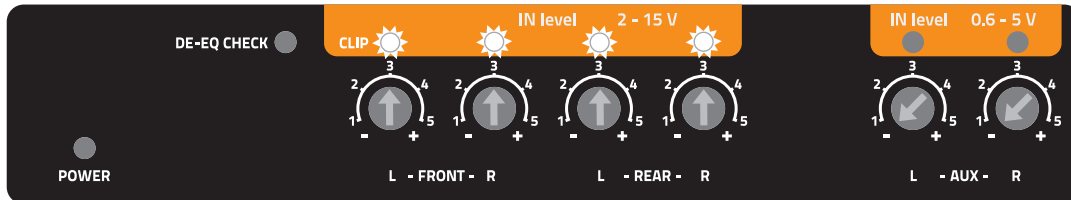

- It is normal for the LED to flash briefly; this indicate correct sensitivity calibration.
- Repeat the procedure for the other 3 Front / Rear knobs.
- Note the calibration level used by the head unit volume control.

**Important:** Some OEM head units require a low load impedance to enable the outputs (usually the Rear section). If during the calibration process the input signal level can not be adjusted, it could be necessary to connect in parallel a 47Ω - 3W resistor to the input cables of the channels showing the issue.



Select **BACK** to go back to the previous step.  
 Select **NEXT** to go ahead with the setup procedure.  
 Select **CANCEL** to exit the procedure

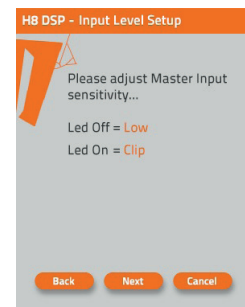

**WARNING:** OEM audio systems installed as standard by car manufacturers often provided with equalized outputs. This means that the response curve is not flat and the difference between the highest and the lowest level can reach 6 dB. By calibrating the device so that the LED never lights up, the **H8 DSP** sensitivity may be suboptimal (low) and you may experience noise (whistle) on the speakers. A few quick LED flashes indicate only a small distortion when handling maximum peaks (very occasional) of music tracks. If the source is not equalized, response is flat and the LEDs will always be on or always off. In this case, calibrating is easy because you will simply need to adjust the knobs so that the LEDs turn off just below the point they turn on.



## 10. Integrated speakers selection

Speakers can be selected just by clicking on them.

If the left tweeter, left midrange or left woofer are selected, the software provides the ability to automatically also activate the right tweeter, right midrange or right woofer.

Once started, this choice sets the dedicated crossover type and frequencies with default settings. If you do not use passive crossover filters, each speaker corresponds to an output channel. The **H8 DSP** features 8 output channels; without passive crossover filters 8 amplified channels can be driven. Of course you can select more than 8 speakers, in which case the system will help implement passive crossovers

Select **BACK** to go back to the previous step.  
 Select **NEXT** to go ahead with the setup procedure.  
 Select **CANCEL** to exit the procedure.

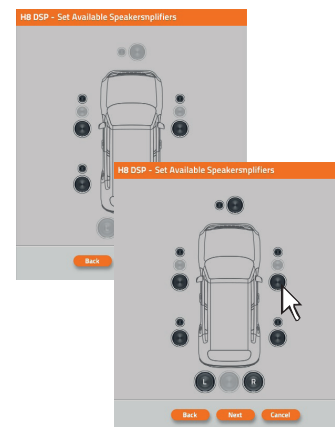



### 11. Speaker groups passive crossover selection.

E' possibile indicare la presenza di crossover passivi che gestiscono gruppi funzionali di altoparlanti.

**E.g.:** If the audio system includes passive crossovers, the software will request to set them up, otherwise select NEXT. A 2 or 3-way passive crossover only takes a single channel. If the sum of crossovers and / or speakers exceeds 8 output channels, the software will not enable the following operation. Recheck the crossover setting or, by selecting BACK, the speaker configuration

**WARNING:** A coaxial speaker should be considered a Tweeter + Woofer + 2-way Crossover



Select **BACK** to go back to the previous step.  
 Select **NEXT** to go ahead with the setup procedure.  
 Select **CANCEL** to exit the procedure.

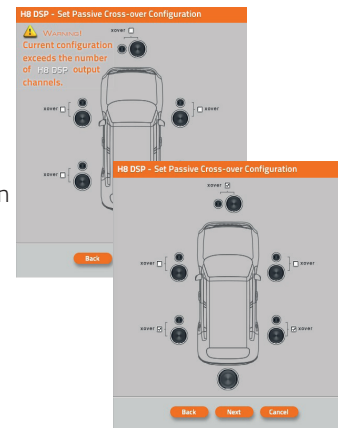

### 12. Processor PRE OUT outputs (Ch1÷Ch8) allocation.

The **H8 DSP** features 8 PRE output and the software will automatically assign a number from 1 to 8 for the analogue outputs.

With DEFAULT settings the channels available are the following:

**CH1**=Front TW LEFT; **CH2**= Front TW RIGHT; **CH3**= Front WF LEFT; **CH4**= Front WF RIGHT; **CH5**= Rear FULL LEFT; **CH6**= Rear FULL RIGHT; **CH7**= Center CHANNEL; **CH8**= SUBWOOFER.

Automatic numbering can be adjusted using the cursors next to the numbers. In case a number is repeated or incorrect an error message will be appear.

To then check if the channel number and the actual name (e.g. 3=CH3 -> Front WF LEFT) are consistent, open the **CHANNEL MAP** (See 8.8)

Select **BACK** to go back to the previous step.  
 Select **NEXT** to go ahead with the setup procedure.  
 Select **CANCEL** to exit the procedure.

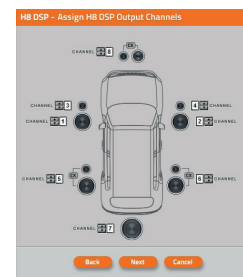

### 13. Source equalization analysis.

Source de-equalization (De-Eq) is required only when the source is equalized.

OEM sources often feature a high output level (speaker output) with preset equalization that can not be deleted.

By replacing the OEM audio system (speakers and / or amplifiers), this equalization is harmful. The **H8 DSP** has an automatic procedure to verify equalization and, if present, can eliminate it.

Select **BACK** to go back to the previous step.  
 Select **NEXT** to go ahead with the setup procedure.  
 Select **SKIP** to skip the de-equalization procedure and go to point 16

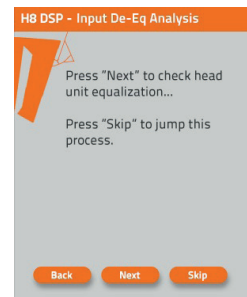

### 14. Equalization analysis: source setting.

To run this procedure, follow the instructions listed below:

- Disconnect all the **H8 DSP** RCA outputs (Front, Rear, Sub) if already connected to the amplifiers.
- Play track 2 of the **H8 DSP** CD.
- Set all tone and equalizer controls to zero (0).
- Set balance and fader to center (0).

If the calibration volume is lost, to find it simply proceed again as described in paragraphs 8.1.8 - 8.1.9 and verify that the IN LEVEL LEDs flash occasionally. The DRC can display the calibration level, if the system is provided with one (See 10.2).

Select **BACK** to go back to the previous step.  
 Select **NEXT** to go ahead with the setup procedure.  
 Select **CANCEL** to exit the procedure.

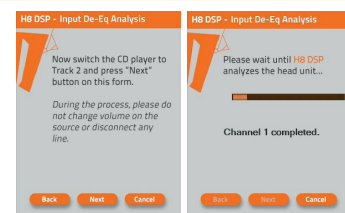

15. Once the analysis is complete, the following messages could be displayed

- **Head unit is equalized:** The head unit is equalized, so we recommend to de-equalize the signal afterwards.
- **Head unit is not equalized:** The head unit is not equalized, so you do not need to de-equalize the signal afterwards

Select **BACK** to go back to the previous step.  
 Select **NEXT** to go ahead with the setup procedure.  
 Select **CANCEL** to exit the procedure.

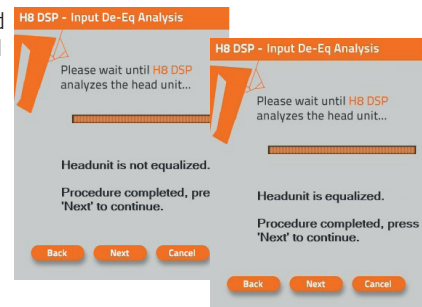

16. Source de-equalization.

Select **BACK** to go back to the previous step.  
 Select **NEXT** to go ahead with the de-qualization.  
 Select **SKIP** to skip the de-equalization procedure and proceed to point 19.

**Important:** Confirm or skip the de-equalization process within 5 minutes, otherwise the **H8 DSP** will automatically reset and turn off.



17. De -equalization procedure.

If you decide to run the procedure, follow the instructions as below:

- Play track 2 of the **H8 DSP** Setup CD (press Play);
- Set all source tone controls to zero (0);
- Set source balance and fader to center (0);
- Don't change the source volume level previously set through the input calibration.

Select **BACK** to go back to the previous step.  
 Select **NEXT** to go ahead with the de-equalization.  
 Select **CANCEL** to exit the procedure.

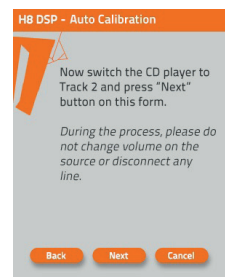

18. Through a real-time progress bar and specific messages, the software shows how the procedure is being executed.

Once the procedure is complete, you will see "**Press Next to Continue**".

Select **BACK** to go back to the previous step.  
 Select **NEXT** to go ahead with the setup procedure.  
 Select **CANCEL** to exit the procedure.

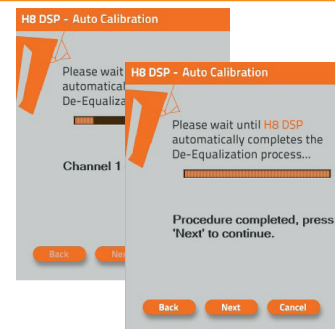

19. System configuration successfully completed.

Stop playing the Test track, remove the supplied Setup CD from the CD player of your head unit and then select **OK**.

Once the de-equalization is complete, the H8 DSP DE-EQ CHECK LED will turn on indicating that you have recorded a curve. If the de-equalization is repeated, new data will replace the previous one.

To clear the memory and turn the DE-EQ CHECK LED off [see 6.2.2.](#)

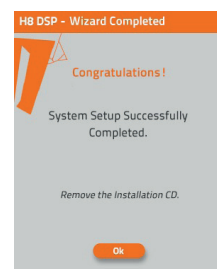

## 20. Software Startup

The settings selected during the guided procedure are transferred to the processor main memory. Once this operation is complete, a message confirming that the update is complete will be displayed. Select **OK**.

We recommend to finalize the product and avoid losing data stored during calibration (see 8.5.3) with the **FINALIZE TO H8 DSP** function, from the main **FILE** menu.



## 21. Amplifiers sensitivity calibration.

Once the **H8 DSP** input calibration or De-Equalization (if any) procedures are complete, you can calibrate amplifier's sensitivity. If you proceed according to the following procedure, you will achieve the best acoustic results and eliminate any possible background noise

1. Connect the different amplifiers channels to the speakers.
2. Connect the **H8 DSP** PRE outputs (**CH1÷CH8**) to the amplifiers inputs using high quality RCA cables.
3. Set the amplifiers sensitivity of the various channels to about 4.0 Volts. Then proceed according to one of the two following procedures

### A. Amplifiers sensitivity calibration by listening.

- Place the head unit volume where the **H8 DSP** inputs were calibrated and play a highly dynamic track.
- Work on the amplifiers sensitivity controls slowly bringing them to higher sensitivity (less than 4.0 Volts). Once the first distortion symptoms show you should stop. This is easier if you work on one channel (stereo) at a time by disconnecting the other channels / amplifiers inputs.
- Once the amplifiers are calibrated, reconnect all the system channels and, if necessary, reduce the sensitivity (back to 4.0 volts) of those channels that may have excessive volume.

### B. Amplifiers sensitivity instrument calibration.

For instrument analysis, you will need an oscilloscope.

- Disconnect all speakers from the amplifiers if already connected.
- Play track 1 of the **H8 DSP** CD. All source controls must be flat (0). The volume control should be placed on the **H8 DSP** input calibration level.
- Connect the oscilloscope to an amplifier output channel. The video will display a sine wave with variable frequency (sweep).
- Turn the sensitivity control in both directions until the sine wave looks slightly cut at both ends.
- Repeat for each amplifier channel.
- Reconnect the speakers and insert a CD with a music track. Reduce the sensitivity (by turning the knob toward 4.0 volts) of those channels that may have excessive volume.

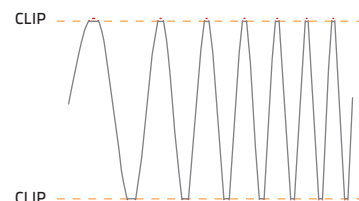

4. The flattening of the functional groups acoustic intensity obtained through the amplifiers sensitivity calibration is an approximate adjustment. The **H8 DSP** applies the standard settings by default. After the acoustic settings described in the following paragraphs are performed, you will be able to refine the functional groups acoustic flattening by acting on the **H8 DSP** outputs (see 8.13).

## 22. Aux In input sensitivity calibration.

Once the system is calibrated and fully working through the Front / Rear inputs, you can calibrate the AUX IN inputs.

**AUX IN:** DRC (optional) must be installed in order to activate this input or through the use of the dedicated

**AUX SEL** terminal (see 4.4.4).

- If a source with a CD player is connected to the AUX input, disconnect the H8 DSP outputs from the amplifiers and proceed as detailed in chapters 6.1.3 - 6.1.4.

- If the source to be connected to the AUX IN input has no CD player (e.g. mp3 player), you can calibrate by listening.

**A** - Connect the **H8 DSP** RCA inputs (AUX IN) to the head unit output.

**B** - Play a music track.

**C** - Turn the IN Level / AUX knobs until the first distortion symptoms appear. Check if the IN Level / AUX LEDs flash occasionally.

## 8.2 OFFLINE MODE

In this mode, even if the **H8 DSP** processor is connected to the PC, it does not interact with the software.

The **OFFLINE** mode (see 8.1.3) can be used to work on the software without connecting the **H8 DSP** to the PC to get familiar with the many functions of the processor or to save settings that can be used later (see 8.5.1).

The software is pre-set to start with a 2 Way FRONT +REAR +CENTER+SUB multi-amplified system.

To set a new "virtual" system, and so to change the inputs and select the outputs, you need to select the **function I/O Configuration Wizard** in the **Config** window of the software main menu. Follow the same instructions as the ones for the **TARGET** mode (see 8.1.5).



Here is how the **H8 DSP** software appears when started in **OFFLINE** mode.

## 8.3 ADJUSTING ACOUSTIC REPRODUCTION

The following chapters detail the system adjustments and acoustic tuning features.

**WARNING:** We recommend that you do not modify the settings of your **H8 DSP** to explore its features.



Take your time to get familiar with the possibilities this software offers.

If you decide to leave the amplifiers connected to the **H8 DSP**, remember to perform the adjustments keeping the general volume at a level that does not damage the speakers in your system.



### 8.4 DEVICE INFO 1

This window indicates whether the **H8 DSP** is correctly connected to the PC and the DRC. It also shows the device Firmware version.

### 8.5 "FILE" MAIN MENU 2

When the File tab is selected a drop-down menu will appear including the entries shown in the image:

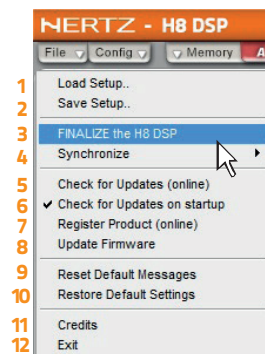

- 1. Load Setup:** Load Setup: the entire **H8 DSP** configuration is loaded from a previously saved file (e.g. "H8Config.dip"). This feature is available both in **TARGET** and in **OFFLINE** mode. In **TARGET** mode, it can be used to load all the settings that have been previously saved. This is useful if you want to resume all the settings you previously selected to install another **H8 DSP** with the same settings. Output levels calibration and de-equalization, if any, must be repeated. In **OFFLINE** mode, it can be used to check the features you previously saved.

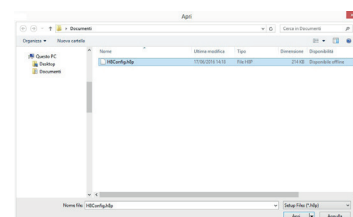



**2. Save Setup:** it enables the storage of the entire **H8 DSP** configuration in a file (e.g. "H8Config.dip") that you can subsequently load into the **H8 DSP** through the **Load Setup** function. This feature is available both in **TARGET** and in **OFFLINE** modes.

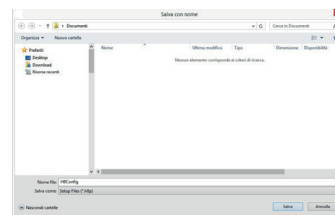

**3. FINALIZE to H8 DSP:** it enables the loading of all the parameters selected while configuring the **H8 DSP** into the internal memory, allowing it to work without being connected to a PC. When selecting the **Finalize to H8 DSP** function, the software notifies you that the data previously saved to the **H8 DSP** will be overwritten.

- Select **YES** to load the data.
- Select **NO** to interrupt the process.

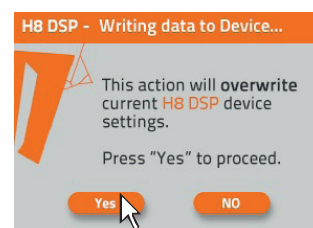

**WARNING:** Before disconnecting the **H8 DSP** from the PC or each time that you exit the PC Software after modifying the system configuration, always run the **Finalize to H8 DSP** procedure. If you do not follow these instructions, all data entered will be lost and the device will use the previous settings.

**4 Synchronize: PC -> H8 DSP, PC <- H8 DSP**

These functions synchronize the PC with the **H8 DSP**.

If a dialog box like the one on the right appears, it means that for some reason communication between the PC and the **H8 DSP** has been interrupted.

To restore the communication, select:

- **PC -> H8 DSP.** The PC loads the settings selected so far into the **H8 DSP**.
- **PC <- H8 DSP.** The PC loads the settings that have been previously stored in the **H8 DSP**

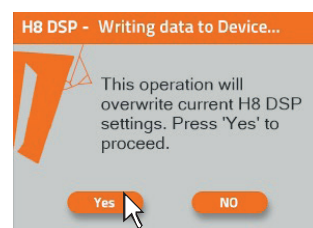

**WARNING:** This operation cannot guarantee that data are always retrieved.

If the operation is not successful, you need to:

1. exit the **H8 DSP** software;
2. turn the **H8 DSP** off;
3. turn the **H8 DSP** on;
4. launch the **H8 DSP** software again.

Synchronization will be restored but the selected settings will be lost

**5 Check for updates:** it enables the connection to the website [www.bitdrive.it](http://www.bitdrive.it), and checks if any software / firmware updates to the **H8 DSP** and **DRC** are available, in order to update the devices you are using. To perform this operation, your PC has to be connected to the internet

**6 Check for Updates on startup:** when enabled the availability of new firmware/PC Software updates is checked automatically each time you start the program.

**7 Register product:** This function requires an internet connection and opens the default browser to the page for registering the product and creating a personal account in the "bit Drive" portal. This operation only needs to be performed once; then you can access your account through the Login Account.

**8. Update Firmware:** select to update the **H8 DSP** firmware ([see 9.3](#)).

**9. Reset Default Answer:** it restores the display of warning messages if they have been disabled by checking "**Don't show me again**".

**10. Restore Factory Defaults:** entirely resets the **H8 DSP** back to its default settings, cancelling all data previously saved in the processor.

**11. Credits:** it shows information about the **H8 DSP** software in use.

**12. Exit:** exits the PC software.



## 8.6 "CONFIG" MAIN MENU 3

If you click on the Config tab, a drop-down menu appears listing the entries shown in the image on the right:

1. **I/O Configuration Wizard:** it enables the system calibration and allowing the **H8 DSP** to function in the required conditions (see 8.1.5).
2. **Working Mode - Standard / Expert:** the software can work in two modes, acting on the crossover filter.
  - **Standard:** simplified mode with some restrictions easing the use of the software (see 8.10).
  - **Expert:** no restrictions to the use of the software (see 8.10). We suggest to try and use the software in **Expert** mode; if it is too difficult, change to **Standard** mode.

**WARNING:** When you change from one mode to the other, the filters are restored to their defaults



3. **Current Input Type:** it displays the specialization assigned to the **MASTER** inputs.
4. **Start up/Shutdown delays:** it enables the modification of the **H8 DSP** turn on / off time settings
  - **StartUp Time:** delay between turning the device on and audio output activation. Every amplifier exhibits, while turning on, its own delay before being operational. If you set Startup Time to a value higher than or equal to the longest of these delays, the entire audio system will be synchronized.
  - **Shutdown time:** delay between turning the **REMOTE OUT** signal off for the amplifiers and turning the **H8 DSP off**. It is generally not necessary to change this parameter, but can be decreased if your amplifiers produce a **"Bump"** when shut down
5. **External Source:** : it provides the ability to enable or disable auxiliary sources selected or left out during the I/O configuration Wizard (see 8.1.6).
6. **Help:** when activated by selecting **"Active"**, it enables the display of context messages regarding the software section in use. Different languages connected to the context messages can be selected from a drop-down menu.

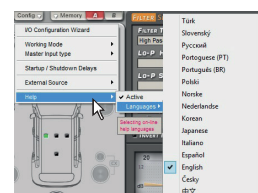
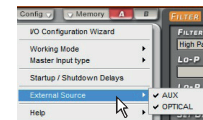
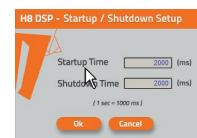
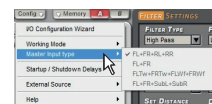
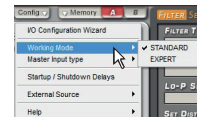
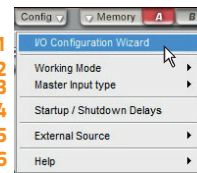

E.g.: Help

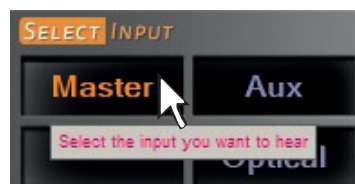



## 8.7 SELECTED INPUT 4

The **Select Input** window shows the source that is active while the **H8 DSP** is connected to the PC. You can select the desired source by clicking on it. Once the **H8 DSP** has been disconnected from the PC, you can select the **H8 DSP** input source through the DRC or the terminal wire (see 4.4.4 / 4.4.5).

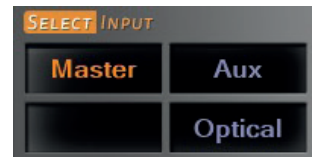

## 8.8 CHANNEL MAP 5

This window displays the names given to the output channels. When this window is active, you can manage each channel which, once selected, will be highlighted.

By keeping the **CTRL** key pressed and clicking on the other channel will be selected and highlighted. The filter curve simultaneously appear on the graph.

Multiple selection is only allowed for functional groups, except for the Subwoofer that can be selected with any group

**E.g.:** Front Left Full can be selected with Subwoofer but not with Rear Left Full. If you want to check the Rear + Subwoofer system, you have to de-select the Front system.

The software only allows you to work on a single channel and will display the word **EDIT** in red next to the corresponding channel.

In particular, the graph will display a red line only for the electrical response of the crossover corresponding to the editing channel, a blue line for the overall electrical response of all selected channels, taking into account the crossover filters and equalizations, and a green line for the final result.

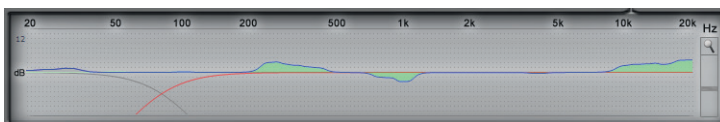
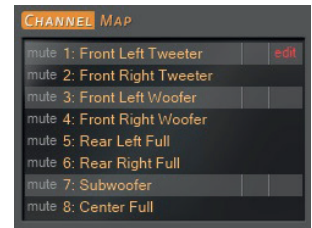

To act on another channel and keep your selection, click to the right of the desired channel, where the **EDIT** column is.

The **CHANNEL MAP** window allows to silence each channel by clicking on the word **MUTE** to the left of the desired channel.

If **MUTE** is on, the word is highlighted in green.

You can also select a channel as shown in the image next to the following chapter 8.9

## 8.9 SELECT CHANNEL 6

This window is active. You can select the speakers or the speaker system to manage each single channel that, once selected, will be highlighted. By keeping the **CTRL** key pressed and clicking on the other channel will be selected and highlighted, similarly to what happens with the Channel Map (see 8.8).

### Listening point visual marker

The Select Channel window also includes this function (shown in green).

Four points are pre-set: driver, passenger, front center and rear center for the corresponding passengers.

This marker acts only and exclusively as a visual reference for the digital delay set up for that specific listening position (see 8.11). If delays are set according to the "driver" position and then you want to optimize the system also for the "passenger" position, you need to set the distances through the specific menu (see 8.11) again, as the system does not update them automatically.

If used together with the presets (see 8.14), it is useful to try different setups according to the different listening positions.

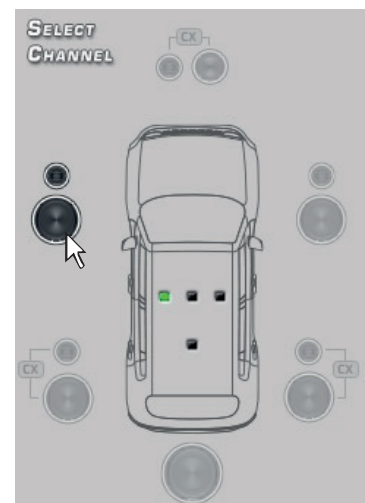

## 8.10 FILTER SETTINGS 7

The **H8 DSP** has five crossover filters, one for each output channel. Each filter allows the setting of a single output channel parameters

1. **Xover L/R Link:** modifications applied to one of the channels (right or left) will also automatically be applied to the other one. To do so, click on the blue led which will light up. **Xover L/R Link** manages all **Filter Settings** adjustments except **Set Distance** (Delay).
2. **Invert Phase:** it inverts the phase of the channel under examination by 180°. This can be done by selecting the green light which will light up. This can be useful to solve phase alignment problems among the different filtered channels.
3. **Filter Type:** it enables the selection of the different types of filters that can be assigned to channels:
  - Full Range
  - Low Pass
  - High Pass
  - Band Pass

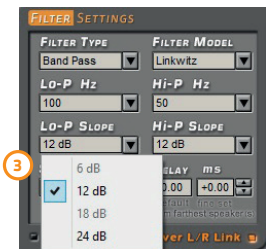
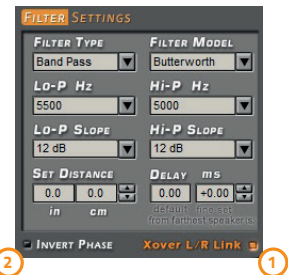

### In STANDARD mode:

According to the speaker or speaker system selected during setup, suitable filter types will be available.

**E.g.:** for the Front Woofer only Low Pass or Band Pass will be available. For the Front Mid-Hi only High Pass and Band Pass will be available, etc

### MODALITA' STANDARD

| FILTER TYPE -> | Full Range | Low Pass | High Pass | Band Pass |
|----------------|------------|----------|-----------|-----------|
| Tweeter        |            |          | X         | X         |
| Midrange       |            |          |           | X         |
| Woofer         |            | X        |           | X         |
| Mid-Hi         |            |          | X         | X         |
| Subwoofer      |            | X        |           | X         |
| Full           | X          | X        | X         | X         |

### In EXPERT mode:

Every speaker system selected has every filter type available.

**WARNING:** In EXPERT mode, pay utmost attention to the filter selection. Speakers have mechanical limits that must not be exceeded, otherwise they could cause permanent damage. When you select a filter, some optimized cut-off frequencies are set by default to avoid breaking the speakers.



**E.g.** if you select Low Pass for a tweeter, the default frequency is instead suitable for a woofer and not for the tweeter, which may be damaged.

### MODALITA' EXPERT

| FILTER TYPE -> | Full Range | Low Pass | High Pass | Band Pass |
|----------------|------------|----------|-----------|-----------|
| Tweeter        | X          | X        | X         | X         |
| Midrange       | X          | X        | X         | X         |
| Woofer         | X          | X        | X         | X         |
| Mid-Hi         | X          | X        | X         | X         |
| Subwoofer      | X          | X        | X         | X         |
| Full           | X          | X        | X         | X         |

4. **Filter Model:** it enables the selection of the type of filter to be applied.
  - Linkwitz (default)
  - Butterworth

When launching the H8 DSP software, it suggests Linkwitz as the standard filter model for the speaker or speaker group connected to the corresponding channel. To apply the opposite solution (Left / Right), turn the Xover L/R Link on.

If you modify the model to Butterworth, the change will be applied to both.

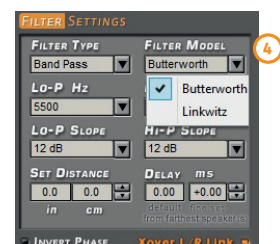

## 5. Cut-off frequencies

- **Hi-P Hz** 10 ÷ 20000: filtro High-Pass
- **Lo-P Hz** 10 ÷ 20000: filtro Low-Pass

If you select the **Band-Pass** filter, both **Hi-P Hz** and **Lo-P Hz** boxes will be available to set up the band frequency. You can select the cut-off frequency by:

- clicking on the corresponding drop-down menu, selecting the frequency range that includes the value to be set, and then the actual value;
- clicking on the corresponding drop-down menu, selecting the frequency range and then moving from one value to the other by using the arrow keys (up / down) on the PC keyboard;
- clicking on the corresponding drop-down menu and then moving from value to value with a mouse featuring a rotating scroll wheel.

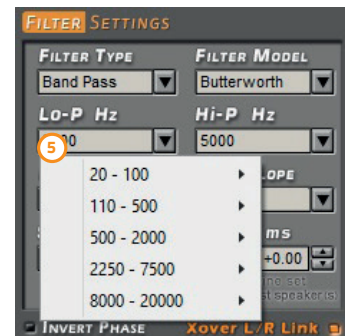

In **STANDARD** mode the crossing frequency for speakers of the same front is bound to a -3 dB crossover.



**E.g.:** If you change the Front Woofer low pass cut-off frequency, the Front Mid-Hi hi-pass cut-off frequency will also automatically change. If you change the Subwoofer low-pass cut-off frequency, instead, the Front Woofer hi-pass cut-off frequency will not change.

In **EXPERT mode** the crossing frequency for speakers of the same front is free, meaning that cut-offs can be created with a value other than -3 dB.

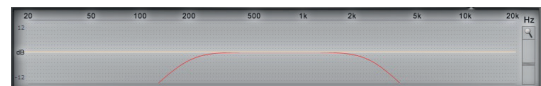

## 6. Filter slope

- **Hi-P Slope** 12/24 dB/Oct (Linkwitz) 6/12/18/24dB/Oct (Butterworth)
  - **Lo-P Slope** 12/24 dB/Oct (Linkwitz) 6/12/18/24 dB/Oct (Butterworth)
- When starting the software the **H8 DSP** offers Linkwitz with 12 dB/Oct. slope by default.

**E.g.:** If you select Band Pass as filter type, the slope will be applied to both hi-pass and low-pass as the default slope, but it is also possible to unbind them.

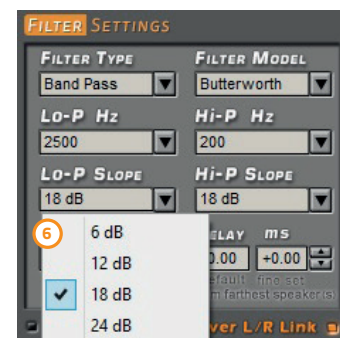

The crossover filter response corresponding to the selected channel is displayed on the graph with a red curve, as in the examples below

**E.g.:** Band Pass



Crossover Frequency 80 - 2000 Hz @ 12 dB/Oct

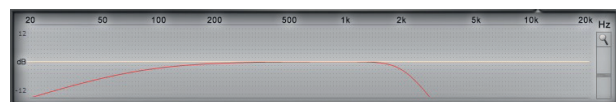

Crossover Frequency 80 Hz @ 6 dB/Oct. Hi-pass  
2000 Hz @ 24dB/Oct. Low-pass

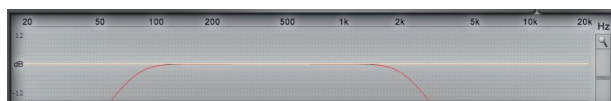

Crossover Frequency 80 - 2000 Hz @ 24 dB/Oct.

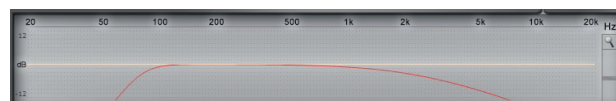

Crossover Frequency 80 Hz @ 24 dB/Oct. Hi-pass  
2000 Hz @ 6 dB/Oct. Low-pass

## 8.11 SET DISTANCE AND DELAY 8

This setting automatically calculates the time it takes for the speaker sound to reach the listener's ear (Fig. 1).

### Preliminary Remarks

Sound moves through the air at a speed of 343 m/sec (1.125 ft/sec) at a temperature of 20°C (68°F). If you know the distance from the sound emission point, you can then calculate the time sound takes to reach the listener's ear. If you set the distances of the different speakers in your system, the **H8 DSP** will automatically change them into time (ms - milliseconds). It does not assign a delay (0.0 ms) to the farthest speaker (usually the Subwoofer) but progressively growing delays as much as the other speakers get closer to the listening point, in order for all the emission points to reach the listening point at the same time.

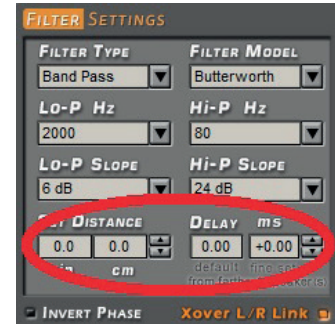

Fig. 1

### SET DISTANCE

It enables the setting of the distance between the speaker and the listening point. Choose cm (centimeters) or in (inches). The **Set Distance** boxes can be configured by using the knobs or by typing the numbers on the keyboard.

### DELAY ms/default

It displays the time in ms (milliseconds) calculated according to the distance.

### DELAY ms/fine set

The H8 DSP time delays also allows the manual fine-adjustment.

### Preliminary Remarks

#### Fine Set and Phase Delay

Delay assignment according to distance calculation is theoretical. That is, small variations need to be applied due to small errors in distance measurement, back-wave reflections inside the car compartment and, mainly, the speaker phase problem.

Two speakers reproducing two areas of frequency close to each other (e.g. Woofer and Midrange) will simultaneously reproduce in their crossing area, at attenuated level, the same frequencies. Due to the different nature of the speakers, they will show a difference in phase that, for a short frequency interval, works like a time delay. By using **Fine Set** you can partly correct these problems of **Phase Delay**.

By using **Fine Set** you can change the preset time delay.

This delay adds to (+ x.xx) or is deducted from (- x.xx) the value of the delay shown in the **Delay / Default** window, and does not change the value automatically assigned.

If you assign a positive value (+ x.xx) with the "**fine delay**" it will increase the delay of that speaker taking it at a further distance from the listening point. Likewise, assigning a negative value (- x.xx) will decrease the speaker's delay and therefore bring it closer to the listening point.



Fig. 2

For the user to evaluate how much **Fine Set** has been manually changed, both delay values are shown. To see the result applied to the output, the values shown in the **Delay / Default and Delay / Fine Set** boxes need to be added up. A negative value (decreasing the delay) can not be assigned to the farthest speaker; it can only be assigned to the other speakers as they are all already delayed compared to the farthest one. If you try and give a negative value to the farthest speaker, an alert message will appear (Fig. 2). When using **Fine Set**, the letters **Fds** will be shown in green on the corresponding channel of the **Channel Map** (Fig.3).



Fig. 3

### Example of time delay setting (Fig.4):

1. Choose the system listening point.  
To identify the listening point, choose an ideal point located at the center of the listener's (driver or passenger) head.  
For the front center and rear center points choose an intermediate point between the two (left / right) listeners.
2. Measure the distance between each speaker or group of speakers and the listening point in a straight line ("as the crow flies").  
For each speaker choose the center of the mobile membrane as the emission point.  
For groups of speakers choose an intermediate point between them.  
It will then be possible to perform fine tuning by using the Fine Set function. (fig.6)
3. Select the channel related to the speaker under examination on the Channel Map and enter the respective distance value in the Set Distance box of the Filter Settings menu. (fig.5)
4. Repeat step 3 for each channel.
5. Perform all time delays settings, start playing music and select the Fine Set box. By shifting the values between positive or negative (except for the Subwoofer in Fig.6 since it is the farthest speaker), the best time alignment and correct acoustic scene can be obtained.  
It is advisable to listen to different types of music (percussion, melodic, etc.) for a comprehensive evaluation of the different musical instruments coherence (space stability).
6. Once the time alignment procedure is complete, you can work on the output equalizer (see 8.12), to optimize the system response in accordance with the level alignment of different frequencies.

**Remark:** measurements for the above operations can also be taken by using a spectrum analyzer with an appropriate microphone.  
The results must be assessed with final refining listening tests.

**WARNING:** If you click on the "passenger" listening point once the distances for the "driver" listening point has been set, the H8 DSP will not re-calculate the delays for the new reference point because the buttons available in the SELECT A CHANNEL diagram are merely descriptive. Their only purpose is to remind you that you have set the delays for that specific listening point!

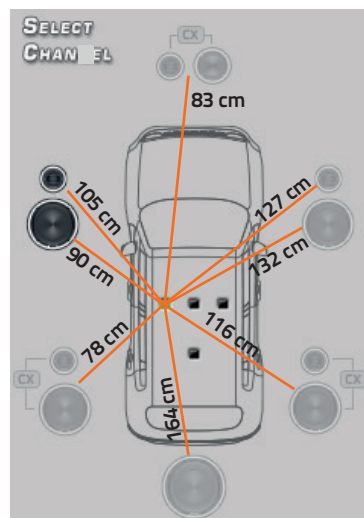

Fig. 4

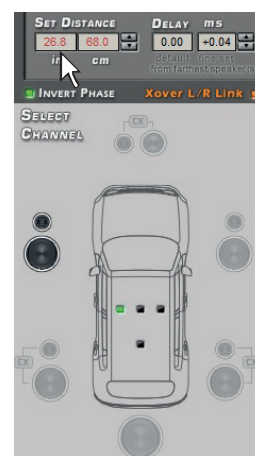

Fig. 5



Fig.6



## 8.12 GRAPHIC EQUALIZER

9

The **H8 DSP** software features a 31-band,  $\pm 12$  dB graphic equalizer for each system channel. In compliance with ISO requirements, frequencies are equally spaced at 1/3 Oct. from 20 to 20 kHz. The equalizer works by groups. By default the equalizer groups will be:

- one equalizer for the **Front**.
- one equalizer for the **Rear**.
- one equalizer for the **Center**.
- one equalizer for the **Subwoofer**.

**E.g.:** examining the system described so far there would be:

- one equalizer for the **Front Mid-Tweeter**.
- one equalizer for the **Front Woofer**.
- one equalizer for the **Rear**.
- one equalizer for the **Center**.
- one equalizer for the **Subwoofer**.

In order to set an equalization curve, the only requirement is to select the channel to be equalized from the **Channel Map** menu and left-click the slider you want to set with the mouse.

To shape an equalization curve, the only requirement is to right-click the first slider on the left of the equalizer and move the equalizer sliders towards the right, shaping the curve as desired (see Fig. 1).



Fig.1



The graphic equalizer features five specific functions to ease the calibration (see Fig. 2).

1. **Select ALL** once an equalization curve has been set, this function provides the ability to move all the sliders at the same time.
2. **Flat**, allows for all the sliders to go back to the 0 dB position;
3. **EQ L/R Link** when active, it applies the equalization curve to both the right and the left channel simultaneously.
4. **EQ Off** when active, it provides the ability to disable the equalizer to check its effect without losing its settings.
5. One **Select** button for each equalizable band, providing the ability to move all the selected sliders together.

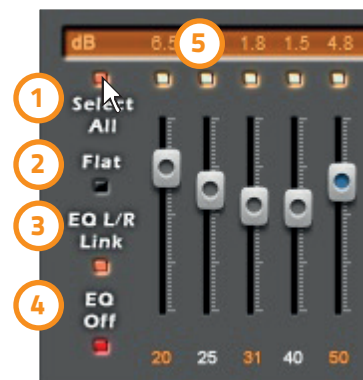
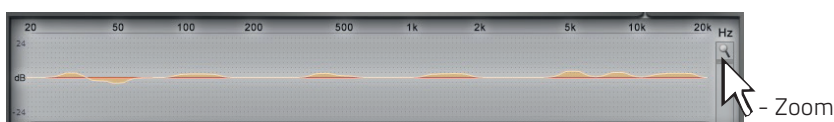
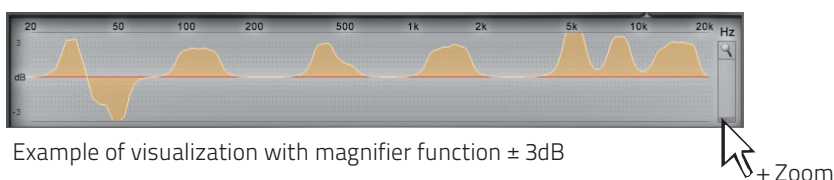

Fig.2

**Remark:** in order to clearly display the set equalization curve, the vertical axis (dB) can be increased or decreased by moving the slider on the right of the equalization curve graph up/down (Fig. 3). By default the graph visualization range is set at  $\pm 12$ dB.



Example of visualization with magnifier function  $\pm 24$ dB



Example of visualization with magnifier function  $\pm 3$ dB

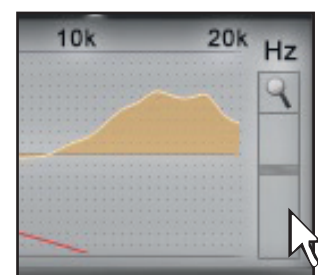
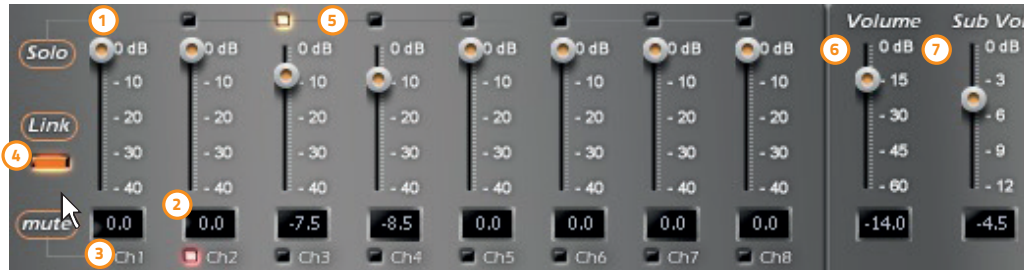

Fig.3

## 8.13 OUTPUT LEVEL 10

This section details the output levels of the H8 DSP channels as displayed by the software. Please note the description of each one of the points marked with numbers in the image below.



- ① By acting on one of the sliders belonging to the output channels, you can adjust the output level (-40 ÷ 0 dB) for each channel. The sliders activate according to the output setup.
- ② This area shows the output level of each single channel (-40 ÷ 0 dB), referred to the outputs slider position.
- ③ By pressing the **"Mute"** button, you can mute the corresponding output channels. By pressing the **"Mute"** button again, the output will be activated.
- ④ By pressing the **"Link"** button, you can simultaneously adjust all the **H8 DSP** output levels. By pressing the Link button again, the function will be disabled.
- ⑤ By pressing the **"Solo"** button the output channels, with the exception of the one already activated, will be muted. By pressing the **"Solo"** button this function will be disabled.
- ⑥ By using the **"Volume"** slider, the general system volume can be adjusted (-60 ÷ 0 dB).
- ⑦ By using the **"Sub Volume"** slider, the Subwoofer output level can be adjusted(-12 ÷ 0 dB), if the system features a Subwoofer.

**Remark:** if the system includes a mono Subwoofer, the sensitivity of its dedicated amplifier needs to be increased by +3 dB compared to the rest of the amplifiers (see the "Amplifiers Sensitivity" chart). This empirical method takes many factors into account and provides a better adjustment of the **"Sub Volume"**.

**Amplifiers Sensitivity (V)**

|                     |     |     |     |     |
|---------------------|-----|-----|-----|-----|
| <b>Front / Rear</b> | 1.0 | 2.0 | 3.0 | 4.0 |
| <b>Sub (+3 dB)</b>  | 0.7 | 1.4 | 2.1 | 2.8 |

- WARNING:** the output level adjustment as detailed in ② affects the system signal / noise ratio (whistle / background hiss). We recommend that you always set the **H8 DSP** output level high and the amplifiers sensitivity low, so that the amplifiers will be less affected by noises / background hisses. Unfortunately, an excessive high output level may cause a on the processor outputs, especially if equalizations with high gain are applied. We therefore recommend that you proceed as follows:
- a- Set the amplifiers at the minimum sensitivity level (3-4 V RMS) if not yet done [\(see 8.1.21\)](#).
  - b- Balance the emission level of the system channels by moving the sliders ① Making sure a mid level centered at around -20 dB is maintained. Turn the output volume to an acceptable listening volume level.

- c- Set the desired output equalizations (see 8.12).
- d- Insert a CD with a highly dynamic track.
- e- Select the "Link" function (4), move the slider and increase the output channels level until possible clipping occurs; in this case move the slider back to at least 2-3 dB (check the value on one of the displays (2)).
- f- Increase the "Volume" (6) to the maximum undistorted level taking it close to "0" dB.
- g- In case the signal is highly distorted with the Master Volume at "0" dB, decrease the output levels (2). If, on the contrary, no distortion occurs, increase the amplifiers sensitivity until the first distortion symptoms will appear: in this way, the whole available undistorted power is obtained.

**Remark:** This procedure leads to calibrate the system at "zero dB undistorted". This is not always the best solution, since a loss in dynamic range may occur, if a track that has been registered at a lower level or with lower dynamic range than the track used for the setup is being played. A good compromise needs to be found, depending on the listener.

## 8.14 MEMORY

11

The **H8 DSP** uses memory **A** by default for the system's configuration; however, it also offers the possibility to store and recall two memories (**A, B**). By pressing the **MEMORY** button on the main menu, different functions are available for the featured presets.

The following functions are available:

- **Load All Presets:** it loads both memories (A/B) from a previously saved file (.prs format).
- **Save All Presets:** it saves both memories (A/B) in a file that can be recalled (.prs format).
- **Load Current Preset:** it loads a previously saved memory (.pro format) by overwriting the memory currently in use.
- **Save Current Preset:** it saves the memory currently in use in a file that can be recalled (.pro format).
- **Copy Preset From:** it copies the content of one memory into the current memory.
- **Current Preset Default:** it restores the crossover and equalization default values that would be suggested at the end of the setup procedure.

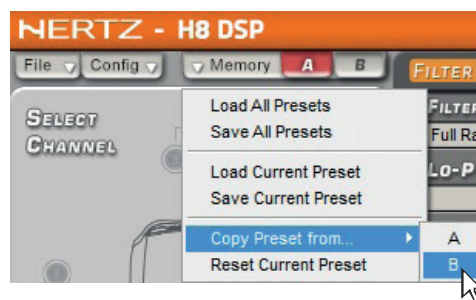

The following data are stored in each memory:

- the filter settings for each channel;
- the time delay settings for each channel;
- the equalization settings for each channel;
- the output levels of each channel;
- listening point markers.

We recommend that you copy the parameters entered in the memory currently in use into the memory that is not being used.

These memories can be recalled through the DRC. If some memories are not saved, they will be configured according to the default settings.



## 9. TROUBLESHOOTING

### 9.1 SYNCHRONIZATION WITH A PC

#### 1. H8 DSP functioning problems

- If, while tuning the system with a laptop PC, the **H8 DSP** should present any functioning problems, try to disconnect the laptop PC power supply cable. In this way, with the laptop PC working on battery power, a possible voltage difference in USB ground between car ground (**H8 DSP**) and earth (PC) can be avoided.

#### 2. The H8 DSP does not connect to the PC software

- If, while tuning the system with a laptop PC, the **H8 DSP** is switched off and then on again, the connection is lost and the software can not "finalize" the selected setup. If you do not want to lose the modifications and setup previously selected, proceed as per the following steps:
  - a-** save the setup as a file on the PC using the function **FILE / SAVE SETUP**;
  - b-** exit the software;
  - c-** turn on the **H8 DSP**;
  - d-** launch the software again;
  - e-** load the setup file again using the function **FILE / LOAD SETUP**.

#### 3. The H8 DSP does not respond

- If, while tuning the system with a laptop PC, the **H8 DSP** does not respond, proceed as per the following steps:
- a-** Spegner l'**H8 DSP**: premendo la manopola del DRC, oppure scollegando il Remote IN, o anche scollegando per un istante il cavo di alimentazione.
  - b-** Salvare il setup in un file sul PC tramite la funzione **FILE / SAVE SETUP**.
  - c-** Uscire dal software.
  - d-** Accendere l'**H8 DSP**.
  - e-** Riavviare il software.
  - f-** Ricaricare il setup salvato tramite la funzione **FILE / LOAD SETUP**.

#### 4. Settings not stored

In order to successfully complete the **H8 DSP** setup and not lose the settings performed, remember to store the selected settings. Select **File** from the main software menu via the PC and then choose **Finalize to H8 DSP**.

### 9.2 BACKGROUND NOISE

#### Loud whistle / background hiss.

In case a loud whistle / background hiss can be heard, it may be necessary to repeat the input sensitivity setup and / or to rectify the output levels adjustment. For more information, see sections [8.1.2 - 8.1.13](#) in this manual.

## 9.3 FIRMWARE UPGRADE

If there are product **UPGRADES** available online, proceed as follows:

- **Save the previous setup (if you wish to consult it in OFFLINE mode);**
- **Disconnect the RCA cables.**

Start **H8 DSP** PC Software and select **TARGET** mode.

1. Access the "**FILE**" menu in the PC management software and choose "**Check for Updates**".
2. When selecting "Check for Updates", the internet browser in the PC will open up and will automatically search for the URL: [www.bitdrive.it](http://www.bitdrive.it). Once the related page is open, click on the LINK for the product.
3. Individuare il file più aggiornato nel cui nome sia contenuta la parola Firmware seguita da quattro numeri e cliccare sul simbolo specifico per avviare il download. Quando richiesto salvare il file sul proprio PC.
4. Selezionare la voce "Update Firmware"; il programma chiederà di selezionare il file appena salvato dall'Area Download oppure precedentemente salvato sul PC.

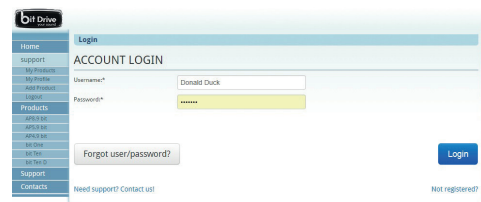

**WARNING:** **H8 DSP** Firmware update procedure may be delicate. It is extremely important that it is performed under the best possible conditions. If the operation is started and prematurely interrupted (e.g.: PC locked up, loss of power to **H8 DSP**, accidental disconnection of the USB cable during update), our After Sales Service might need to be contacted to reprogram the **H8 DSP**



5. Before starting **H8 DSP** update, the program warns you to:
  - not disconnect **H8 DSP** from the PC;
  - not disconnect **H8 DSP** from power;
  - temporarily disable the PC automatic stand-by processes; temporarily disable the PC screen saver;
  - close all running applications; temporarily disable the anti-virus and anti-spyware systems.

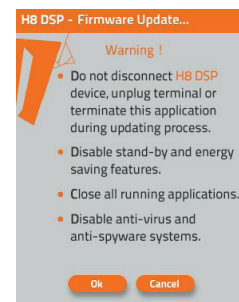

6. Once you have clicked on **OK**, the Firmware update procedure starts. This process will last between 30 seconds and 1 minute; the progress bar and the flashing logo on the **H8 DSP** will show the updating process status.

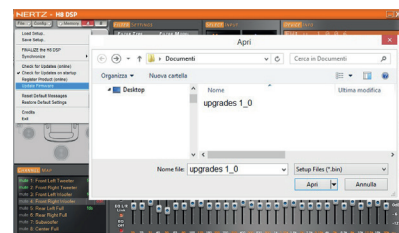

**WARNING:** During the update, the updating process of the progress bar may stop for a few seconds. Do not interrupt the process in any way. When successfully completed, a notification window will appear. To use the **H8 DSP** again, the program on the PC must be closed and the **H8 DSP** turned off.



7. turn the **H8 DSP** back on and restart the PC software. If the **H8 DSP** firmware update is completed correctly, the dialogue window will display:
  - new H8 DSP Firmware version.
8. Repeat the product calibration operations ([see sec. 8.1](#)).

## 9.4 RESCUE MODE

If, when launching the **H8 DSP** PC software the "**H8 DSP Warning**" window appears, the user can choose between the following two ways to proceed:

**A** - Use a previous version of the PC software.  
**E.g.:** when using PC software v.1.0, open v.0.9;

- B** - Update the **H8 DSP firmware**. In this case proceed as follows:
- Save the previous setup (in case you want to open it in **OFFLINE** mode);
  - Unplug the **H8 DSP** from the amplifiers;
  - Turn the **H8 DSP** off, disconnect the power supply;
  - Set the **UPGRADE MODE** to **ON**;
  - Reconnect the power supply and turn the **H8 DSP** on;
  - Restart the **H8 DSP** PC software and select **RESCUE MODE**

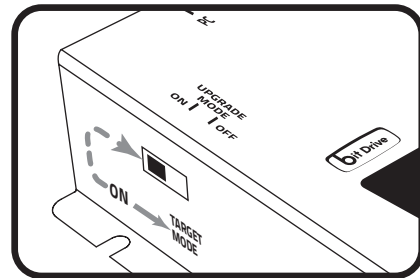

- The screenshot on the right shows the Boot Loader version currently installed on the processor, enabling the access to the menu for the update.



- Proceed as detailed in 9.3.4

**C** - when the update procedure is complete set the switch "**UPGRADE MODE**" to "**OFF**" position.

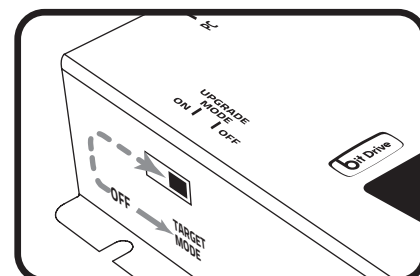

## 10. TECHNICAL SPECIFICATIONS

| <b>POWER SUPPLY</b>                                |  |
|--|--|
| Operating power supply voltage                     | 10.8 ÷ 14.4 VDC  |
| Power supply                                       | 7.5 ÷ 15 VDC   |
| Idling current                                     | 0,4 A  |
| Switched off without DRC                           | 2,5 mA   |
| Switched off with DRC                              | 4 mA   |
| Remote IN voltage                                  | 6,5 ÷ 15 VDC (1,3 mA)  |
| Remote OUT voltage                                 | 12 VDC (130 mA)  |
| <b>SIGNAL STAGE</b>                                |  |
| Distortion - THD @ 1 kHz, 1V RMS Output            | 0,005%   |
| Bandwith @ -3 dB                                   | 10 ÷ 22k Hz  |
| S/N Ratio @ A weighted                             |  |
| Digital input                                      | 105 dBA  |
| Master Input                                       | 95 dBA   |
| AUX Input  | 96 dBA   |
| Channel Separation @ 1 kHz                         | 85 dB  |
| Input sensitivity (Speaker In)                     | 2 ÷ 15 V RMS   |
| Input sensitivity (AUX In)                         | 0,6 ÷ 5 V RMS  |
| Input impedance (Speaker In)                       | 2,2 kΩ   |
| Input impedance (AUX)                              | 15 kΩ  |
| Max Output Level (RMS) @ 0.1% THD                  | 4 V RMS  |
| <b>INPUT STAGE</b>                                 |  |
| High Level (Speaker)                               | FL - FR - RL - RR  |
| Low Level (Pre)                                    | AUX IN   |
| Digital Optical IN (S/PDIF max 96 kHz/24bit)       | OPTICAL IN   |
| <b>OUTPUT STAGE</b>                                |  |
| Low Level Pre (default)                            | FRONT TW L/R, FRONT WF L/R REAR L/R, SUB, CENTER                 |
| <b>CONNECTIONS</b>                                 |  |
| From / To Personal Computer                        | 1 x USB / B  |
| DRC HE   | Audio controls and Memory / Inputs selection                     |
| Optical / AUX select                               | Optical In / Aux wire control + 12V / GND enable                 |
| Memory A / Memory B                                | Memory A / B wire control + 12V / GND enable                     |
| <b>CROSSOVER N.8 (one for each output channel)</b> |  |
| Filter Type  | Full / High Pass / Low Pass / Band Pass                          |
| Filter mode and slope                              | Linkwitz @ 12 / 24 dB<br>Butterworth @ 6 / 12 / 18 / 24 dB       |
| Crossover frequency                                | 68 steps @ 20 ÷ 20k Hz   |
| Phase control                                      | 0° ÷ 180°  |
| <b>EQUALIZER</b>                                   |  |
| On Hi-Levels input (Speaker In)                    | Automatic De-Equalization On                                     |
| Outputs  | N.8 Graphic: ±12 dB @ 31 Band<br>ISO 1/3 Oct. 20 ÷ 20k Hz        |
| <b>TIME ALIGNMENT</b>                              |  |
| Distance   | 0 ÷ 510 cm / 0 ÷ 200.8 inch                                      |
| Delay  | 0 ÷ 15 ms  |
| Step   | 0.08 ms; 2,8 cm / 1.1 inch                                       |
| Fine set   | 0.02 ms; 0,7 cm / 0.27 inch                                      |
| <b>GENERAL REQUIREMENTS</b>                        |  |
| PC connections                                     | USB 1.1 / 2.0 / 3.0 Compatible<br>Microsoft Windows (32/64 bit): |
| Software/PC requirements:                          | XP, Vista, Windows 7, Windows 8, Windows 10                      |
| Graphic card min. resolution:                      | 800 x 600  |
| Ambient operating temperature range:               | 0 °C to 55 °C (32° F to 131° F)                                  |
| <b>SIZE</b>  |  |
| W (Width) x H (Height) x D (Depth) mm/inch         | 191 x 34 x 131 / 7.51" x 1.33" x 4.76"                           |
| Weight kg/lb                                       | 0,6 / 1.322  |

Technology Air-Sound  
Manufactured by  
**elettromedia** Italy

Tutte le specifiche riportate sono soggette a cambiamento senza preavviso

**HERTZ**

PART OF **ELETTROMEDIA** - 62018 Potenza Picena (MC) Italy - T +39 0733 870 870 - F +39 0733 870 880 - [www.elettromedia.it](http://www.elettromedia.it)