

audison

www.audison.eu

SR 4

360W Power Amplifier
Four channel amplifier with crossover

ADVANCED WEB MANUAL



SPECIFICATIONS

Control panel and terminals

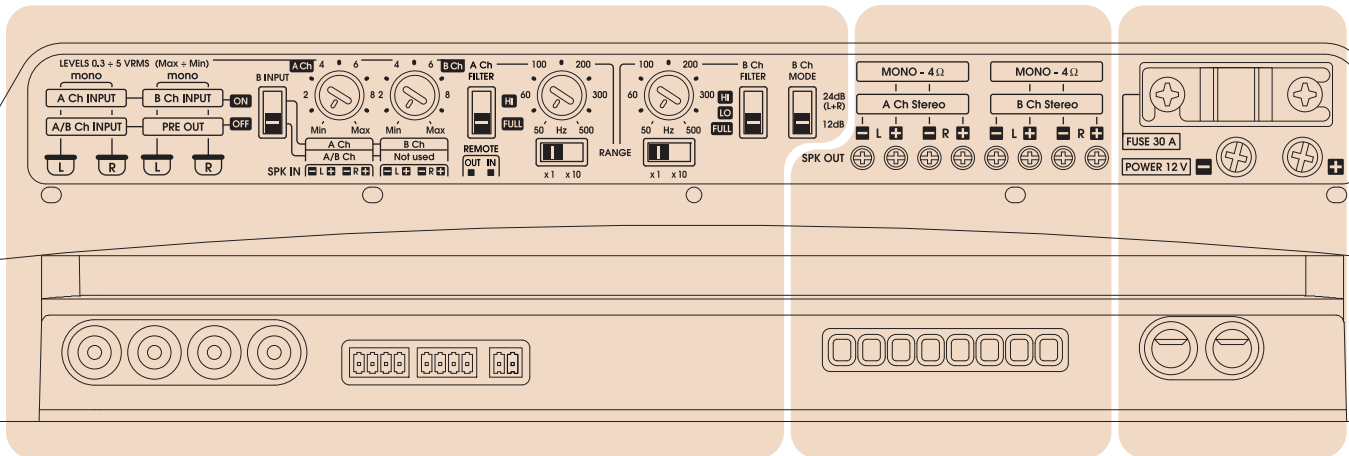

Inputs / Outputs / Functions

Power Outputs

Power Supply

INPUTS

1 PRE IN: A Ch
1 PRE OUT: B Ch

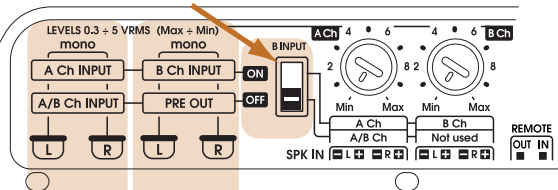

A Ch: PRE IN — B Ch: PRE OUT (Bypass)

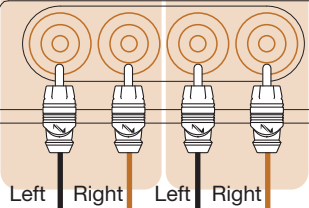

REMOTE OUT REMOTE IN

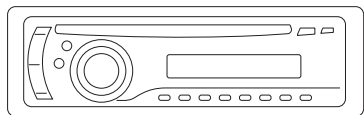

PRE OUT

REMOTE

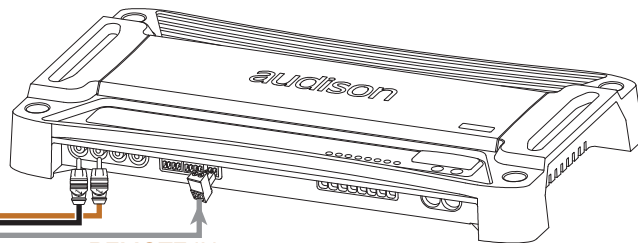

REMOTE IN

INPUTS

2 PRE IN: A and B

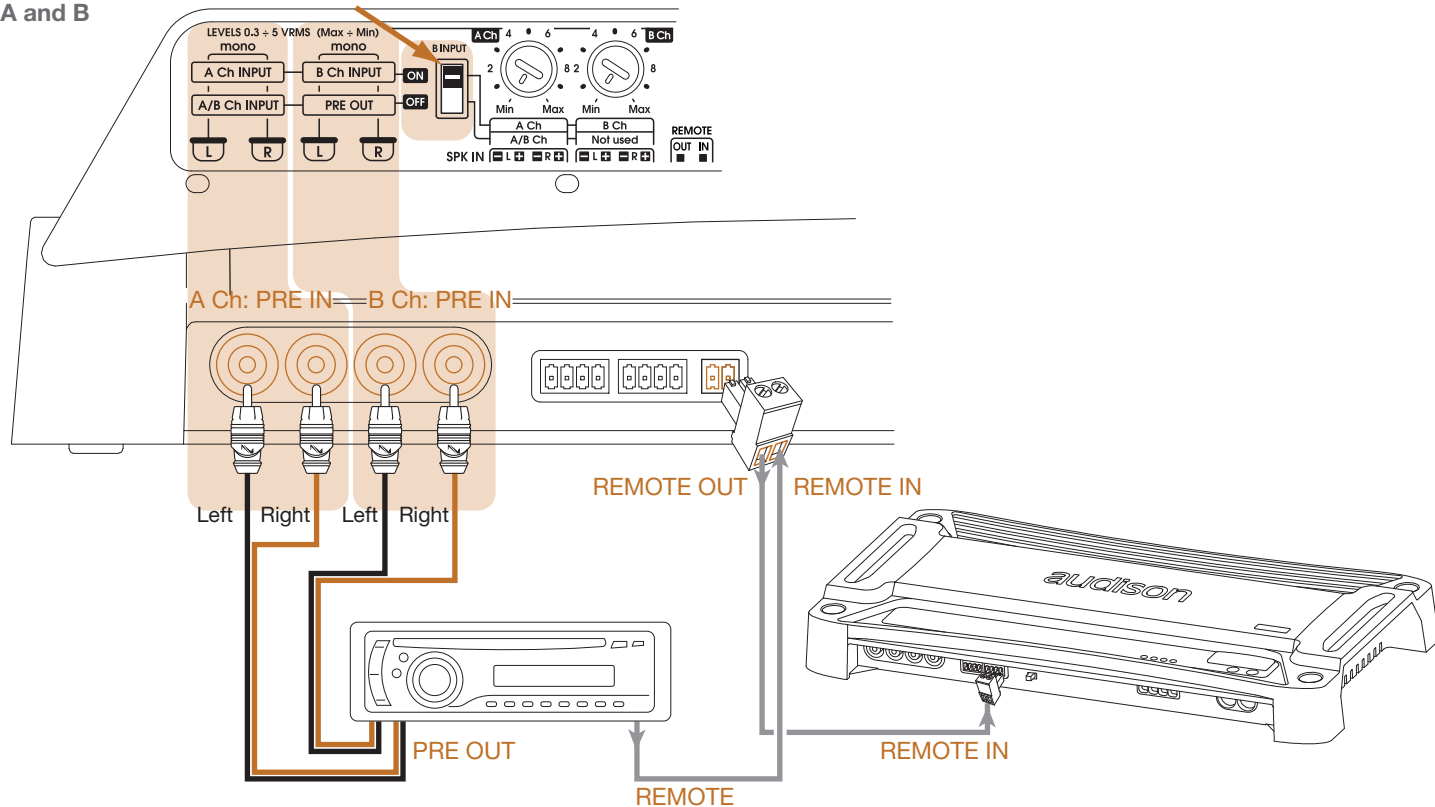

INPUTS

1 SPEAKER IN: A Ch
1 PRE OUT: B Ch

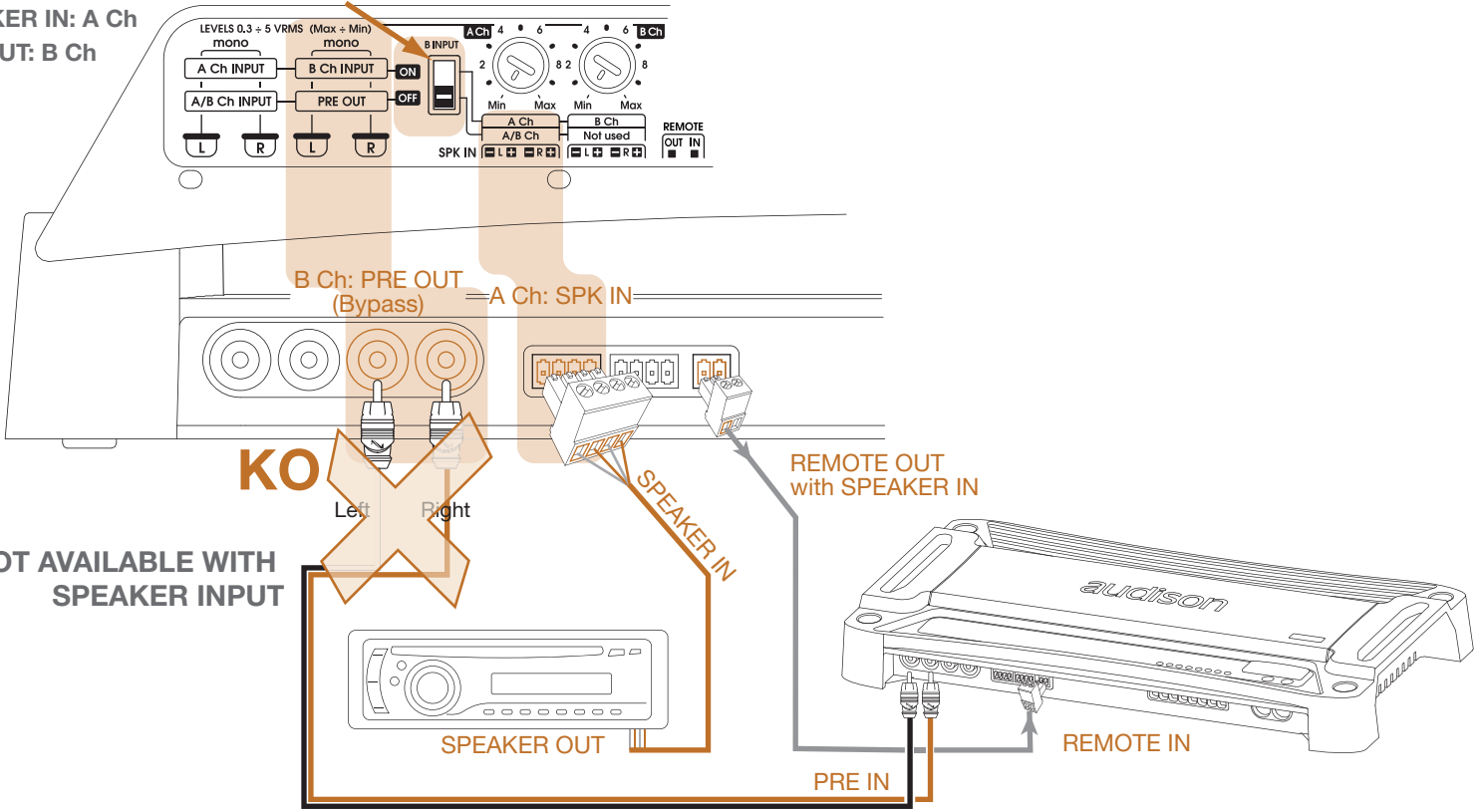

INPUTS

2 SPEAKER IN: A and B

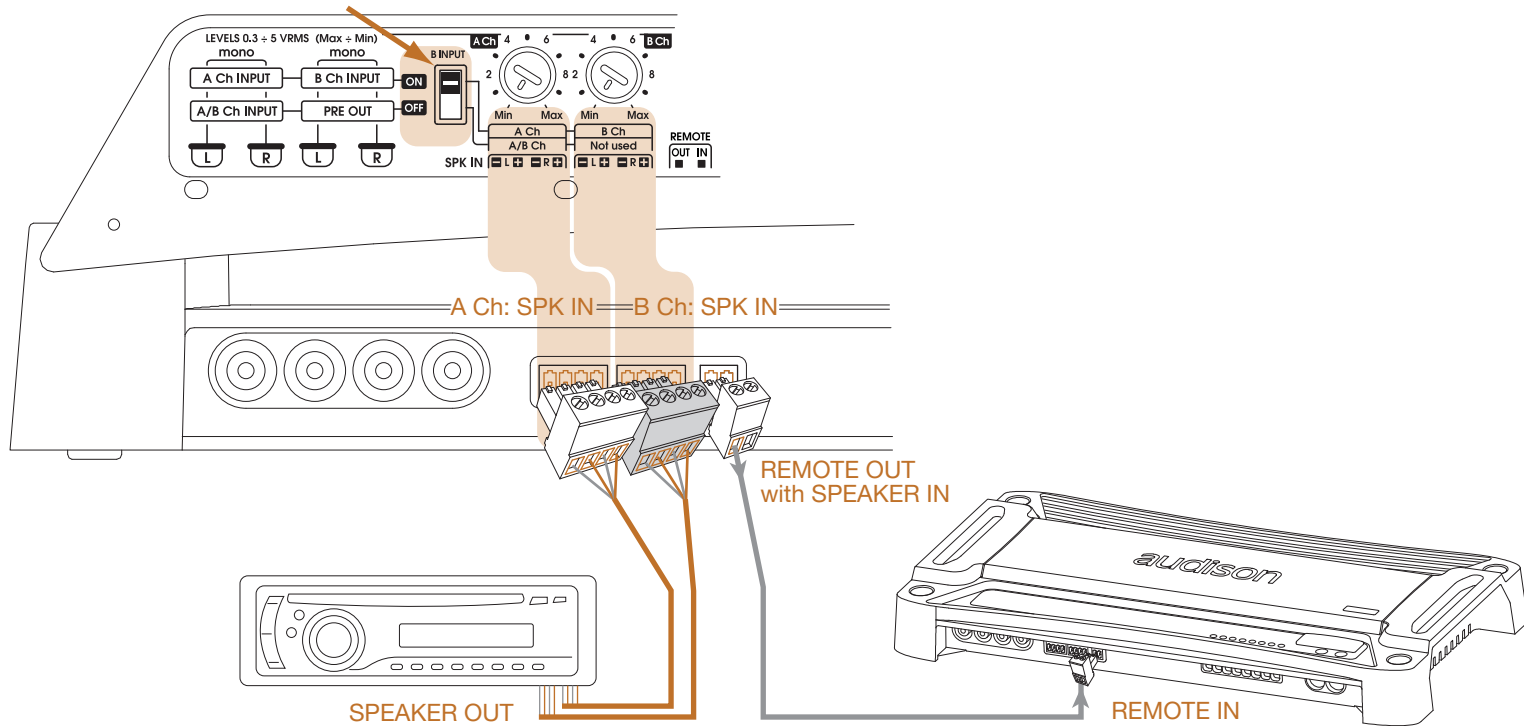

POWER OUTPUTS

4 Channels Mode

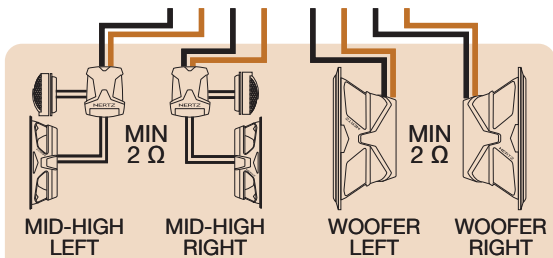
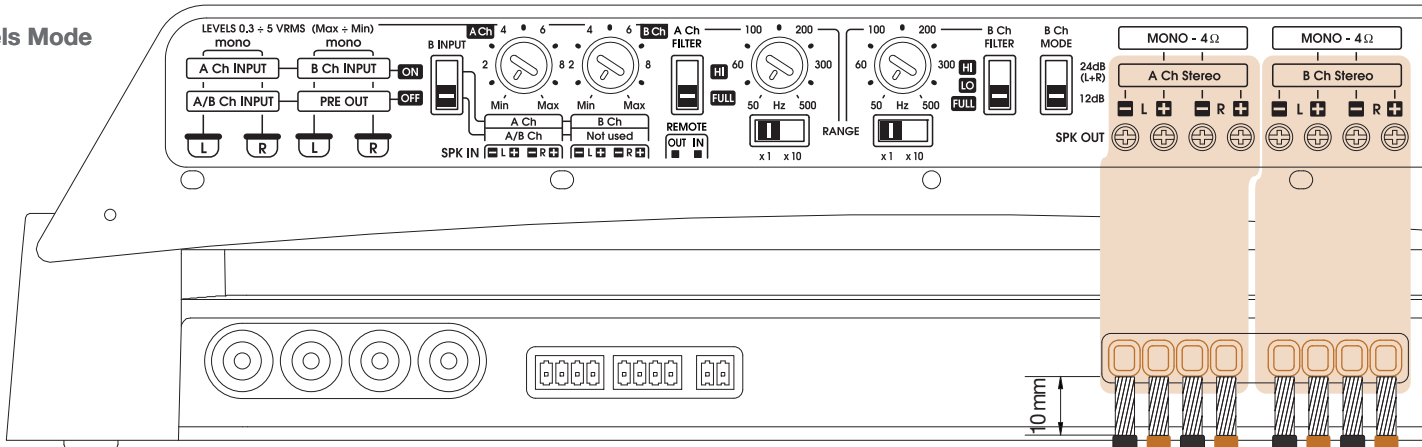

4CH MULTICHANNEL

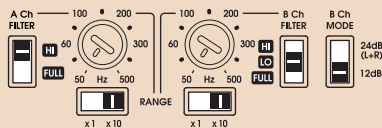

MAX: 8 AWG

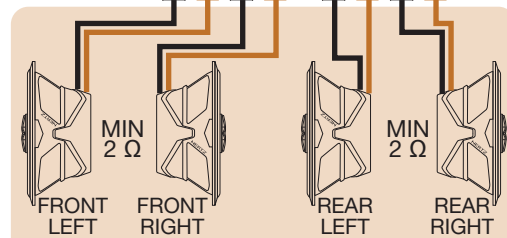

OR

4CH FRONT - REAR

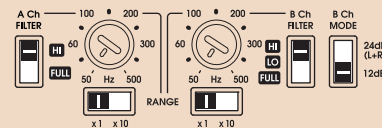

POWER OUTPUTS

3 Channels Mode

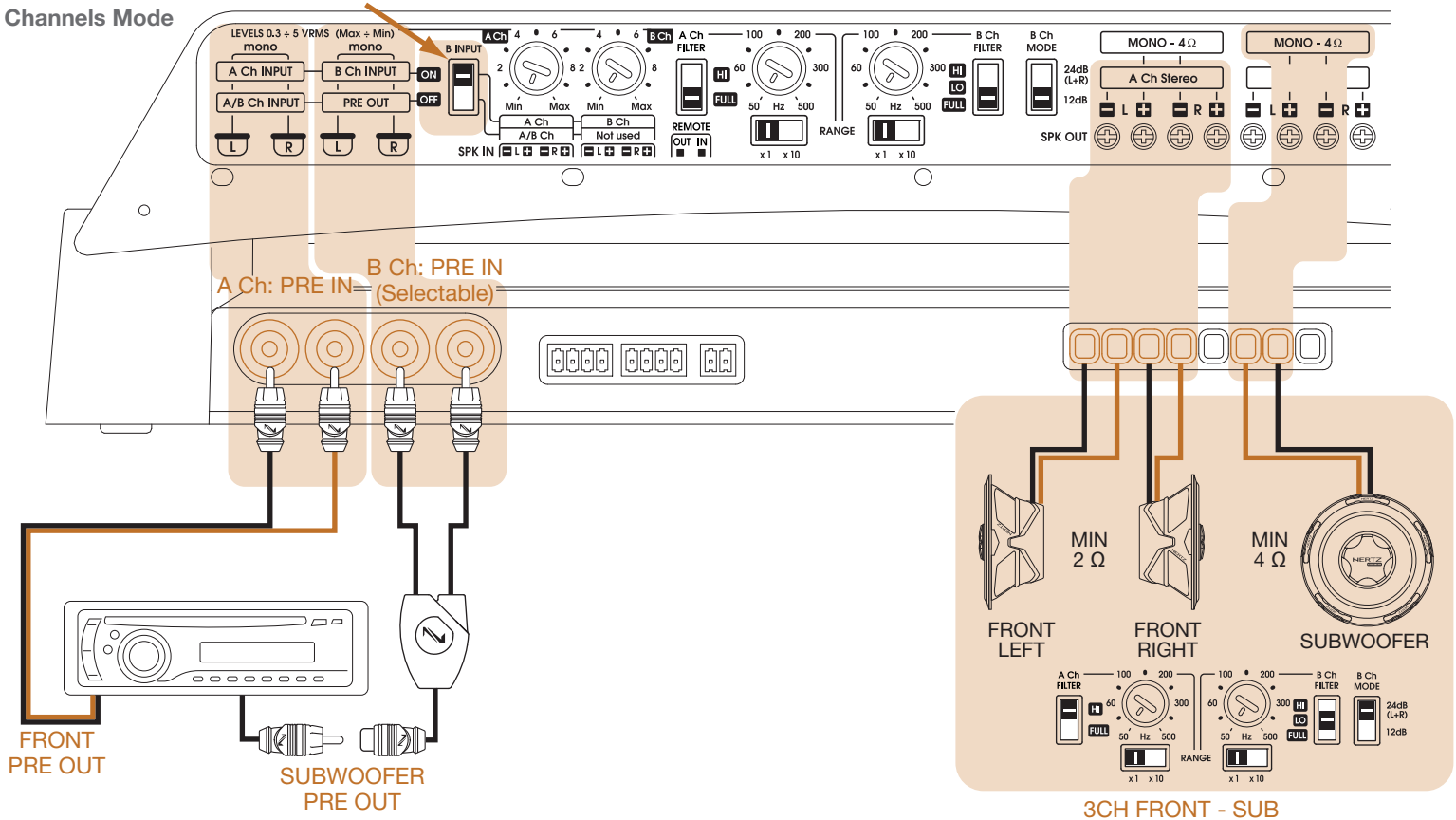

POWER OUTPUTS

2 Channels Mode

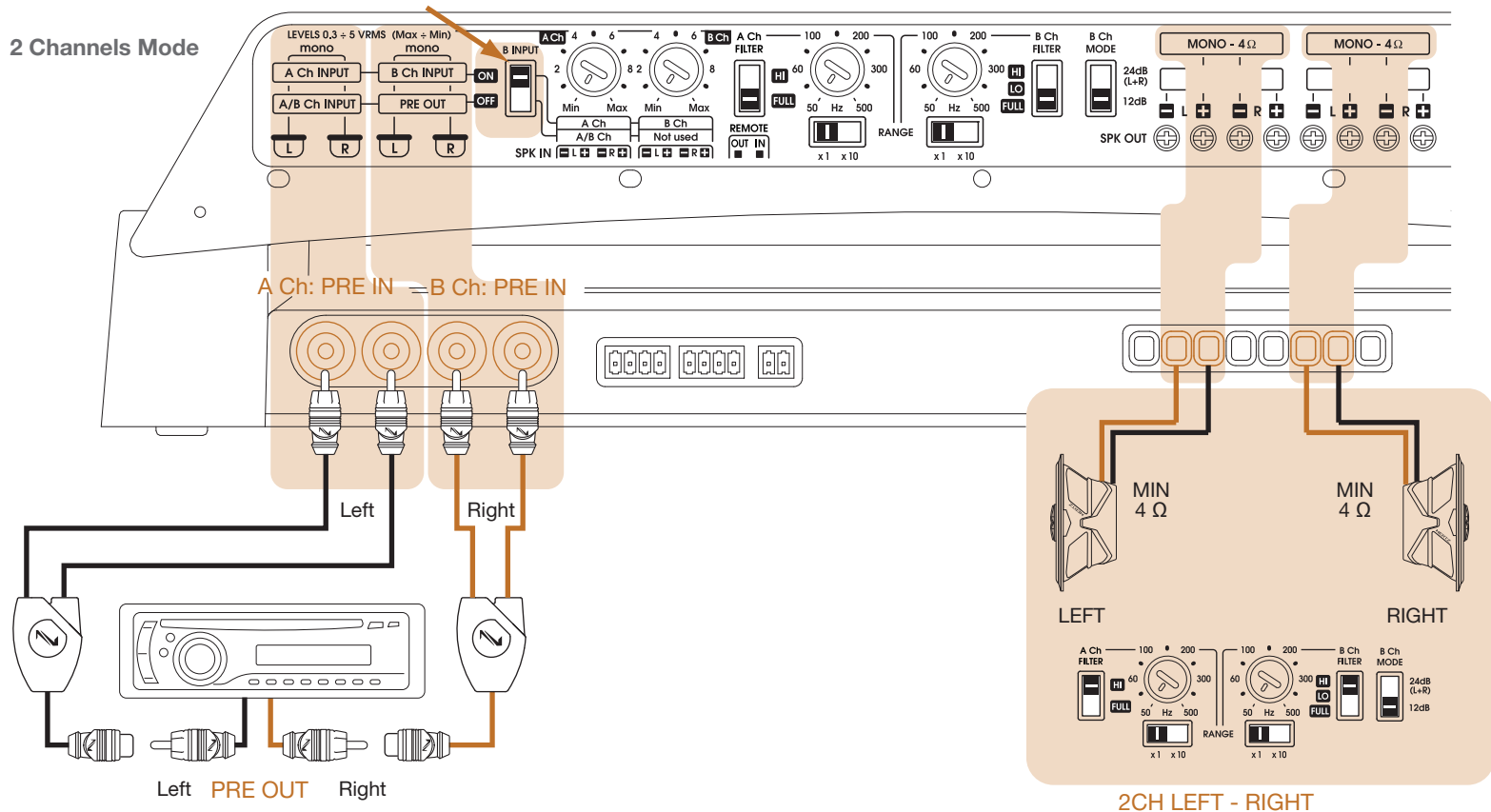

SPECIFICATIONS

Configuration table

Conf.	4CH MODE AMP	A Ch	B Ch
1			
2			
3			
4			
5			
6			

Conf.	3CH MODE AMP	A Ch	B Ch
1			
2			

Conf.	2CH MODE AMP	A Ch	B Ch
1			
2			
3			

4/3 Ch	
A Ch Stereo	A IN A IN
B Ch St/Mo	A IN B IN L and R
B Pre Out	ON OFF

2 Ch	
A Ch Mono	A IN L
B Ch Mono	A IN R
B Pre Out	OFF

COVER and FUSE

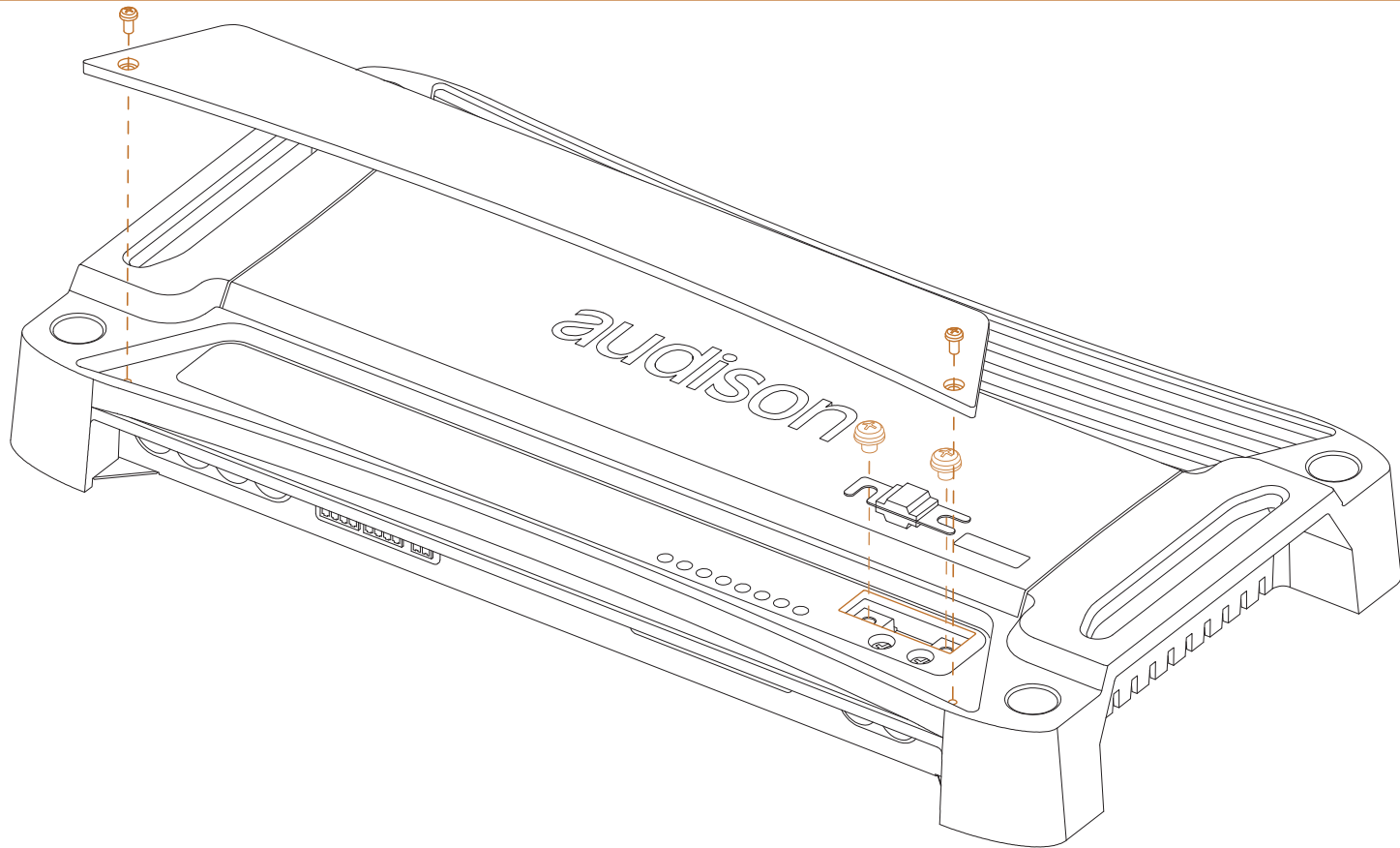

TECHNICAL SPECIFICATIONS

Power Supply

Voltage:	11÷15 VDC
Idling current:	0.7 A
Switched off:	<0.01 mA
Remote IN voltage:	7÷15 VDC (1 mA)
Remote OUT voltage:	11÷15 VDC (15 mA)
Internal fuse (AFS):	30 A
Consumption @ 14.4 VDC, 2 Ω,	
Max Musical Power:	24 A

Inputs/Outputs/Filters

Inputs	Pre IN / Speaker IN
Output	Pre
A Ch Filter	Full / Hi-pass: 50 ÷ 5k Hz @ 12 dB/oct
B Ch Filter	Full / Hi / Lo-pass: 50 ÷ 5k Hz @ 12 / 24 (L+R) dB/oct

Size

WxHxD (mm/inches)	213 x 53.5 x 408 / 8 ^{7/16} x 2 ^{1/8} x 16 ^{1/16}
Weight (kg/lb)	3.3 / 7.28

Amplifier stage

Distortion - THD @ 1 kHz, 4 Ω, 90% Power:	0.08 %
Bandwidth @ -3 dB, 2 VRMS, 4 Ω:	15 ÷ 50k Hz
S/N ratio @ A weighted, 1 V, Max Power:	104 dB
Damping factor @ 1 kHz, 2 VRMS, 4 Ω:	110
Input sensitivity (PRE IN):	0.3 ÷ 5 VRMS
Input sensitivity (SPEAKER IN):	1 ÷ 15 VRMS
Input impedance (PRE IN):	15 kΩ
Input impedance (SPEAKER IN):	100 Ω
Load impedance (Min):	
4 Ch	2 Ω
2 Ch	4 Ω
Nominal power (RMS) @12 VDC; 1% THD, 4 Ω:	45 W x 4
Output power (RMS) @14.4 VDC; 1% THD:	
4 Ch @ 4 Ω	65 W x 4
4 Ch @ 2 Ω	90 W x 4
3 Ch @ 4 Ω	60 W x 2 + 190 W x 1
2 Ch @ 4 Ω	175 W x 2

CEA Specifications

Output Power @	
4 Ω, ≤ 1% THD+N, 14.4 V:	60 W x 4 Ch
S/N ratio (ref. 1W output):	
60 W Channels:	83 dB



audison

PART OF **ELETTROMEDIA** - 62018 Potenza Picena (MC) Italy - T +39 0733 870 870 - F +39 0733 870 880 - www.elettromedia.it