

# DENON<sup>®</sup>

## DHT-S516H

NETWORK SOUND BAR AND SUBWOOFER SYSTEM

# Owner's Manual

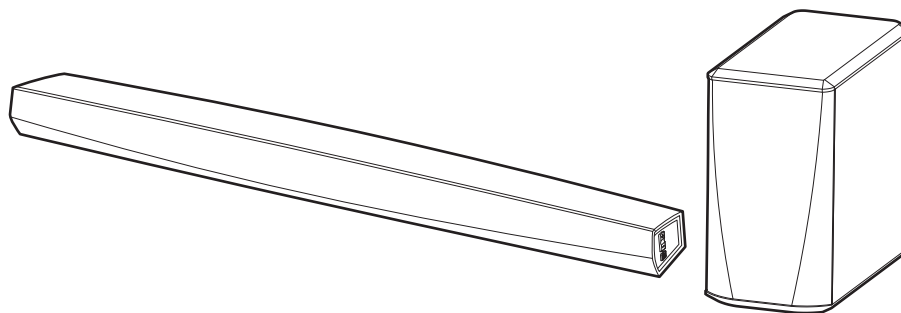

<b>Introduction</b>	<b>6</b>	<b>Using your DHT-S516H for TV</b>	<b>22</b>
<b>Before your begin</b>	<b>7</b>	Connecting to your TV	22
System requirements	7	HDMI connection	22
Network requirements	7	Setting the HDMI control function	22
Controller requirements	8	Disable your television's speakers	23
Getting to know your DHT-S516H	9	1) Playing HDMI (ARC) - Best choice	24
Front panel of soundbar	11	2) Playing HDMI (without ARC) - Better choice	25
Control of soundbar	12	3) Playing digital optical input - Good choice	26
Back panel	13	4) Playing digital coaxial input - Good choice	27
Subwoofer	15	Connecting DHT-S516H to your HDMI equipment	28
Placing your HEOS speaker	16	Listening to TV Audio	29
Placing your DHT-S516H	16	Adjusting the dialog sound	29
Wall-Mounting	18	Listening at night	29
Powering your HEOS speaker	19	Adjusting sound mode	29
Getting the HEOS app	19	Checking the audio status	29
<b>Setting up your first DHT-S516H</b>	<b>20</b>		
<b>Adding more HEOS devices</b>	<b>21</b>		
Adding wired speakers	21		
Adding wireless HEOS devices	21		



<b>Using your DHT-S516H for music</b>	<b>30</b>	Playing from streaming music services	39
Selecting a room/speaker	30	Adding a music service	39
Listening to radio	31	Changing music service settings	39
Playing music stored on your mobile device	31	Listening to the same music in multiple rooms	40
Playing music from your networked PC or NAS	32	Grouping rooms	40
Playing music from a USB device	33	Ungrouping rooms	41
Playing music from Bluetooth device	34	Grouping all rooms (party mode)	42
Pairing the HEOS device with your Bluetooth devices	34	Ungrouping all rooms	43
Playing music from the AUX input	35	Using the now playing queue	44
Managing AUX inputs	36	Play Now	44
Changing the name of the AUX inputs	36	Play Now & Replace Queue	44
Hiding an AUX input	36	Play Next	44
Managing your phone	37	Add to End of Queue	44
HEOS account	38	Rearranging the now playing queue	45
What is a HEOS account?	38	Deleting songs from the play queue	45
Why do I need a HEOS account?	38	Deleting all songs from the play queue	46
Signing up for a HEOS account	38	Saving playlists	46
Changing your HEOS account	38	Performing repeat and shuffle playback	46
		Using the favorites	47
		Adding to HEOS Favorites	47
		Deleting station from the HEOS favorites	47



<b>AirPlay function</b>	<b>48</b>	<b>Updating your system</b>	<b>57</b>
Playing songs from your iPhone, iPod touch or iPad	49	<b>Advanced features</b>	<b>58</b>
Playing iTunes music with this unit	49	Wireless performance	58
Play a song from your iPhone, iPod touch or iPad on multiple synced devices (AirPlay 2)	50	Pairing the soundbar and subwoofer	59
<b>Making speaker adjustments</b>	<b>51</b>	<b>Power management</b>	<b>60</b>
Changing the name	51	Power modes	60
Changing the wireless network connection	51	Quick Start Mode	60
Changing the equalizer and subwoofer level	52	Deep Standby	61
Adjusting the audio quality	52	Off	61
Adjusting the status light brightness	53	<b>Basic troubleshooting</b>	<b>62</b>
Locating the Soundbar	53	No sound	62
Changing the TV connection	53	No subwoofer sound, sound interrupted, or noise occurring	62
Setting the TV Input and Auto-Play	53	Distorted sound from the DHT-S516H	63
Controlling your DHT-S516H	54	Trouble teaching DHT-S516H remote control commands	63
TV Sound Grouping	54	Television speakers keep getting turned back up	63
Advanced settings	55	My speaker won't connect to my network using the audio cable	64
Network settings	55	Music cuts out or delays sometimes	64
About wireless power saving	55	I hear a delay when using the external input with my TV	65
Firmware upgrade	56	Connecting to a network using an iOS device	65
About	56	Connecting to a WPS network	66
		Resetting your speaker	66
		DHT-S516H takes long time to turn on	66



<b>Status LED table</b>	<b>67</b>
<b>Supported file types and codecs</b>	<b>75</b>
Supported audio formats (Coaxial/Optical)	75
<b>Specifications</b>	<b>76</b>
Speaker specifications	76
Soundbar	76
Subwoofer	78
<b>Information</b>	<b>79</b>
Trademarks	79
License	81
License information for the software used in the unit	81



Thank you for purchasing this Denon product. To ensure proper operation, please read this owner's manual carefully before using the product.

**NOTE**

- THIS DOCUMENT CONTAINS INFORMATION THAT IS SUBJECT TO CHANGE WITHOUT NOTICE.

## Introduction

---

The DHT-S516H is part of the HEOS wireless multi-room sound system that enables you to enjoy your favorite music anywhere and everywhere around your home. By utilizing your existing home network and the HEOS app on your iOS or Android™ device, you can explore, browse, and play music from your own music library or from many online streaming music services.

- True multi-room audio - play different songs in different rooms or the same song in every room
- Utilizes your existing home wireless network for quick and easy setup
- Industry leading microsecond audio synchronization between HEOS device
- Legendary Denon audio quality
- If you are in a hurry, you can be enjoying great sounding music in no time by following the steps outlined in the Quick Start Guide (supplied).



Please continue reading this Owner's Manual for more detailed information about the features and benefits of your DHT-S516H.



# Before your begin

---

## NOTE

- If you have already installed at least one HEOS device, please skip to the section "Adding more HEOS devices".

## System requirements

Before you begin installing your first HEOS device, please make sure you understand and meet a few basic requirements.

### ■ Network requirements

**Wireless Router** - In order to use your HEOS music system, you must have a working wireless (Wi-Fi) or ethernet network in your home. Even when connected to an Ethernet network, a Wi-Fi connection to the router is required to control the system using the HEOS Control app. If you do not have a wireless network, please contact your local Denon dealer or electronics retailer to assist you with purchasing and installing a wireless network in your home.

**High Speed Internet Connection** - HEOS accesses the Internet to stream music to your home from many popular online music services. HEOS is also designed to provide you with software updates, which are delivered via your home Internet connection. DSL, Cable, and Fiber services will provide the best experience and reliability. You may experience performance issues with slower Internet connections like satellite based services.



## ■ Controller requirements

You can control your HEOS wireless multi-room sound system using the free HEOS app on any iOS or Android mobile device that meets these minimum requirements:



### iOS Minimum Requirements

- iOS version 8.0 or later
- iPhone® 4S or newer
- iPad® 2 or newer
- iPod touch® (5th generation) or newer



### Android Minimum Requirements

- Android OS version 4.0 or later
- All resolutions





## Getting to know your DHT-S516H

Unpack your speaker from the box and verify that the following items are included:

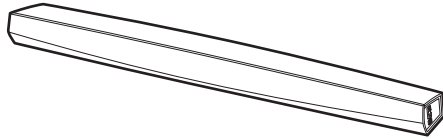

DHT-S516H Soundbar  
(Soundbar)

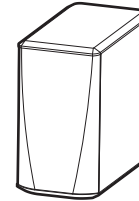

DHT-S516H Subwoofer  
(Subwoofer)

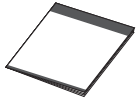

Quick Start Guide



Safety Instructions

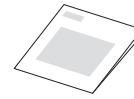

Warranty  
(North America model only)



3.5 mm setup cable

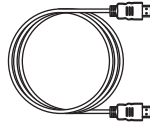

HDMI cable

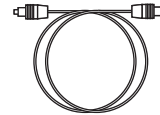

Optical cable



Ethernet cable





IR blaster

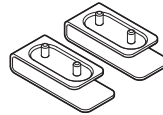

Riser feet



Power cords



Wall mount bumper pads for Soundbar



Non-skid pads for Subwoofer



Wall mount Template

**NOTE**

- Please use the power supply and power cord included in the box for your device.



## ■ Front panel of soundbar

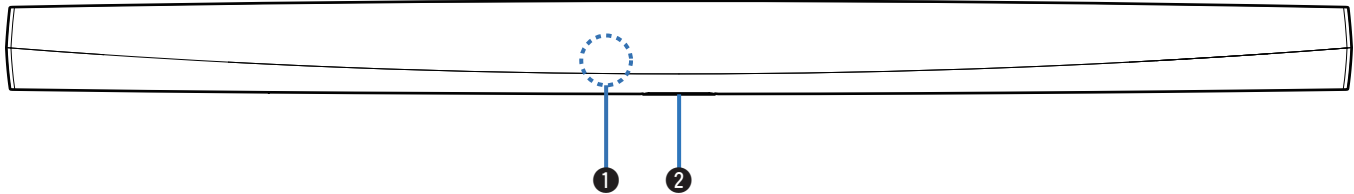

### ① Remote control sensor

This receives signals from the remote control unit. (☞ p. 17)

### ② Status LED

Please refer to the "Status LED table" for LED color and state meaning. (☞ p. 67)



## ■ Control of soundbar

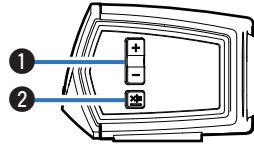

### ① Volume up/down buttons (+, -)

Adjusts the HEOS device's volume level up or down.

### ② Mute button (🔇)

Mutes or unmutes the HEOS device's volume.



## ■ Back panel

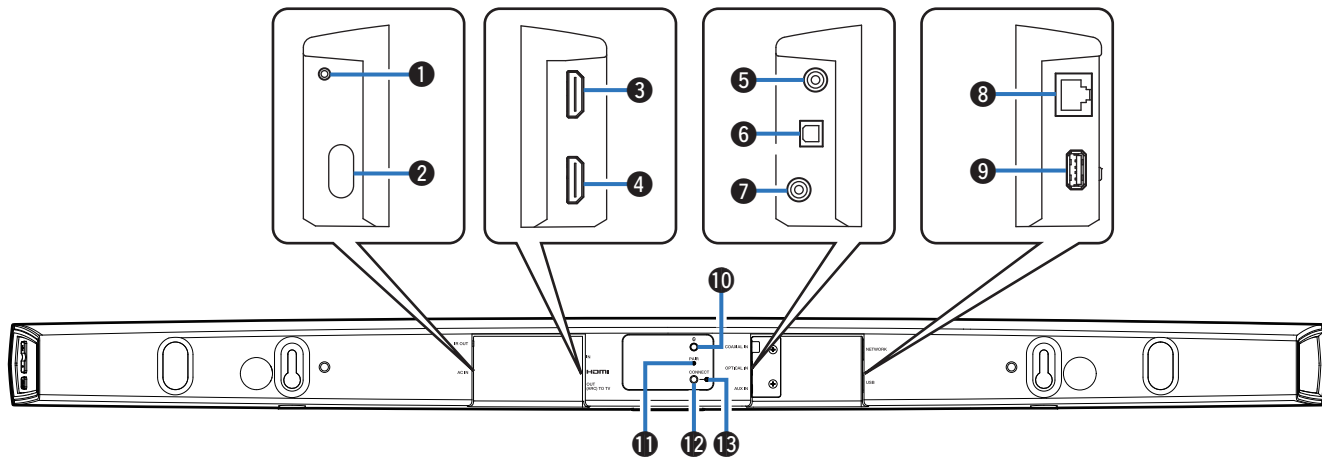

### 1 IR OUT

Used to connect the supplied IR Blaster.

### 2 Power Input (AC IN)

Used to connect the external power supply (👉 p. 19).

### 3 HDMI IN

Used to connect to the HDMI equipment with an HDMI cable.

### 4 HDMI OUT to TV (ARC)

Used to connect to the TV with an HDMI cable. (Compatible with the ARC function)

### 5 COAXIAL IN

Used to connect to television's coaxial digital audio.

### 6 OPTICAL IN

Used to connect to television's optical digital out.

### 7 AUX IN

- Used to connect to television's rear panel audio out.
- Used to add the speaker to your wireless network (👉 p. 21).

### 8 Network Connector (NETWORK)

Used to connect this unit to a wired Ethernet network (👉 p. 21).



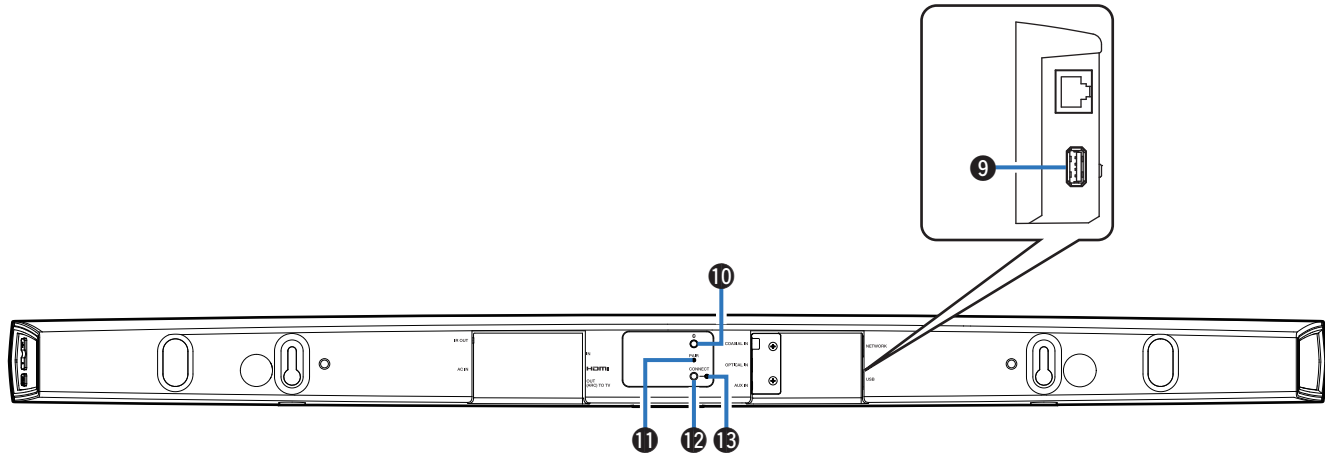

**9 USB port**

Used to connect USB storage devices.

**10 Bluetooth button (📶)**

Used in the Bluetooth pairing settings (👉 p. 34).

**11 Pair Button (PAIR)**

Used to re-pair with subwoofer (Pre-paired at the factory.)

**12 Connect Button (CONNECT)**

Used for Wi-Fi setup (👉 p. 66).

**13 Connect in Status LED**

Indicates the status of this unit (👉 p. 67).



## ■ Subwoofer

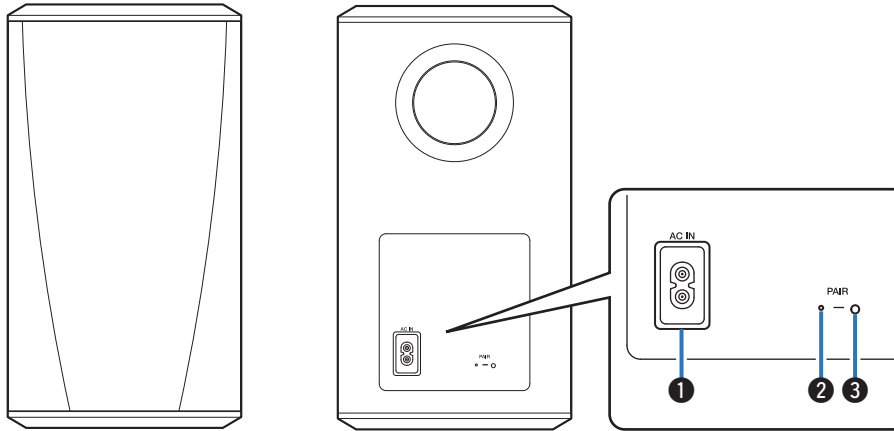

**1 Power Input (AC IN)**

Used to connect the external power supply.

**2 Status LED**

**3 Pair Button (PAIR)**

Used to re-pair with soundbar (Pre-paired at the factory.)



## Placing your HEOS speaker

You can place your HEOS speaker anywhere you want to enjoy great sounding music. Please follow these simple guidelines when determining where to place your speaker...

- The HEOS speaker must be within range of your wireless network.
- Place the speaker across the room from where you will be listening, as close to ear level as possible.
- The HEOS speaker is not waterproof. Do not place it near any water source and do not leave it outside in the rain or snow.

### ■ Placing your DHT-S516H

The soundbar of the DHT-S516H should be placed as close as possible to the television screen. It should be centered left-to-right with the screen, and ideally no more than a few inches above or below. The most common location is below the screen. Sometimes this location can be difficult, because the base of the TV gets in the way. The DHT-S516H has riser feet that raise the soundbar off the shelf, for a more stable and attractive installation when used with this type of television.

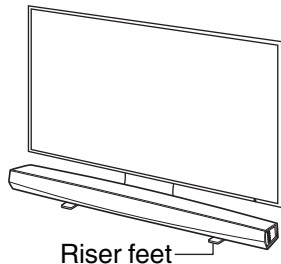

### □ How to attach the riser feet

Attach the supplied riser feet if you need to raise the Soundbar over your TV stand base.

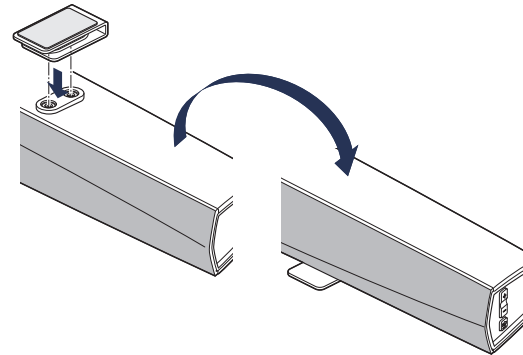



**NOTE**

- Depending on your TV model or installation location, the remote control receiver on the TV may be hidden by the soundbar, preventing the remote control from being used because the remote control signals cannot reach the TV. In this case, connect the supplied IR Blaster. Attach the tip of the IR Blaster near the TV remote control signal receiver and check that the remote control can be used to control the TV.

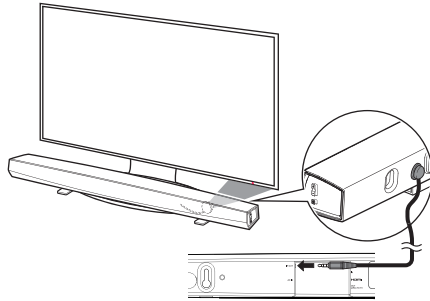

You may also place DHT-S516H soundbar on a shelf, or furniture, above or below the screen. It should be centered with the screen, and ideally no more than a few inches above or below. The system will usually sound best when the front of the soundbar is close to, or flush with, the front edge of the furniture or shelf on which it rests. This reduces unwanted sound reflections.

Place the wireless subwoofer anywhere in the room. For the best sound, place the subwoofer near a wall or corner, within 6 meters of the soundbar, and on the same side of the room as the soundbar. The wireless subwoofer range is 8 meters. Wireless subwoofer can be positioned vertically or horizontally. Attach the supplied non-slip stickers to the subwoofer.

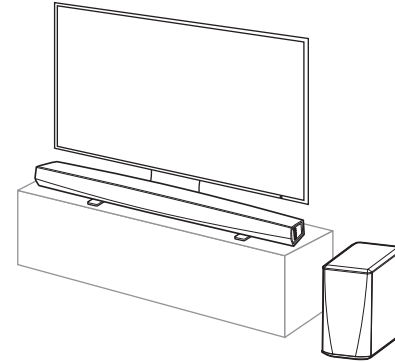
**NOTE**

- Don't put the subwoofer where curtains or furniture will block the sound. The port on the back of the subwoofer cabinet should be unobstructed.



## ■ Wall-Mounting

The DHT-S516H soundbar can be wall-mounted using the integrated keyhole mounts. A mounting template can be found in the product carton. Using a level, position and tape the template to the wall in the desired location. Install hardware\* using the template as a guide and then remove the mounting template from the wall. Connect the audio and power cables prior to mounting the soundbar on the wall.

\* Consult a person knowledgeable about your wall type to recommend suitable hardware for hanging the speaker.

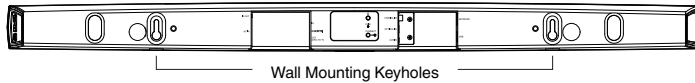

### NOTE

- To ensure safety, request a contractor perform the mounting work when mounting onto a wall.
- In order to use the unit safely, do not place items on or hang items from the unit.
- Be sure to fix connection cables to the wall to ensure that cannot be pulled or tripped over causing the unit to fall. Check that the unit is mounted safely after the mounting work is complete.
- Also, periodically check the safety of the unit and whether there is a possibility that the unit may fall.
- Denon cannot accept any responsibility for damage, injury or accidents caused by problems with the mounting location or mounting method.



## Powering your HEOS speaker

Connect the power cord included in the box to the back of the speaker and the plug to a wall outlet. The speaker is capable of automatically switching between 100 - 240 V.

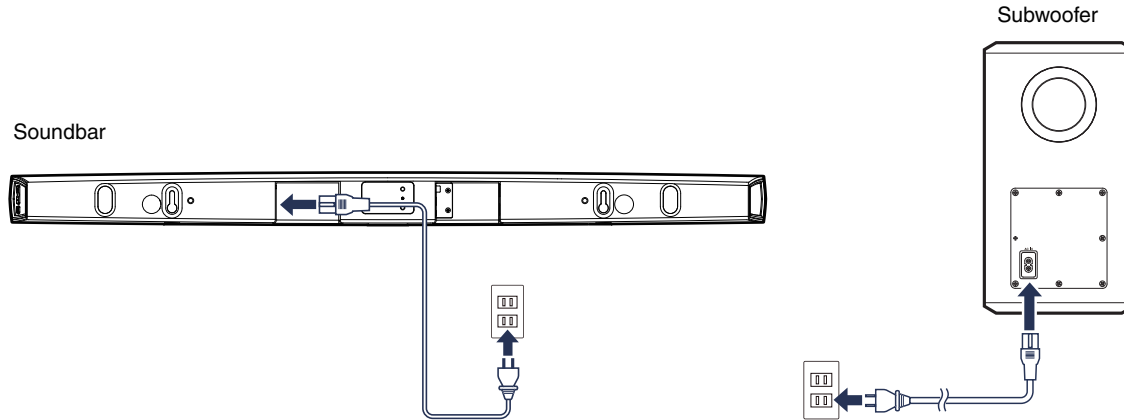

## Getting the HEOS app

The HEOS app is the heart of the HEOS experience. Using your mobile device and the HEOS app, you can setup, browse, explore, and control your HEOS system right in the palm of your hand, from anywhere in your home.

Download the HEOS app for iOS or Android by searching App Store®, Google Play™ store or Amazon App Store for “HEOS”.



amazon appstore

For the purpose of improvement, the specifications and design are subject to change without notice.



# Setting up your first DHT-S516H

Once you have placed your DHT-S516H in your listening room and have downloaded the HEOS app, you are ready to configure your DHT-S516H for music playback. This involves following a few simple steps to get the speaker connected to your existing home network:

## Caution

- DO NOT connect the Ethernet cable if you are connecting your DHT-S516H to a wireless network. If you are connecting the speaker to a wired network, use an Ethernet cable to connect the speaker to your network or router.

## 1 Make sure your mobile device is connected to your wireless network (the same network you want your speakers connected to).

You can check this in the Settings - Wi-Fi menu of your iOS or Android device.

## NOTE

- If your wireless network is secure, make sure you know the password to join your network.

## 2 Make sure you have the included Audio/Setup cable handy.

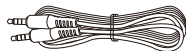

## 3 Launch the HEOS app on your mobile device.



## 4 Tap the “Setup Now” button at the top of the screen.

## 5 Follow the instructions to add the DHT-S516H to your wireless network and to select an input on your DHT-S516H.

The Wi-Fi settings from your mobile device will be copied to the DHT-S516H via the audio cable.

## NOTE

- If you have any problems connecting your HEOS device, jump to the Troubleshooting section. (🔍 p. 62)



## Adding more HEOS devices

The HEOS wireless multi-room sound system is a true multiroom audio system that automatically synchronizes audio playback between multiple HEOS devices so that the audio coming from different rooms is perfectly in sync and always sounds amazing! You can easily add up to 32 HEOS devices to your HEOS system.

### Adding wired speakers

Just connect the HEOS devices to your home network using an Ethernet cable and the HEOS device will appear on your HEOS app as a new room in the Rooms screen.

At your convenience, you can assign a name to the HEOS device to indicate which room you have it placed in.



- Use only a shielded STP or ScTP LAN cable which is easily available at electronics stores (CAT-5 or greater recommended).
- Do not connect a Network Connector directly to the LAN port/Ethernet connector on your computer.

### Adding wireless HEOS devices

You can add additional wireless HEOS devices to your HEOS system by selecting “Add Device” from the HEOS app’s settings menu and follow the instructions:

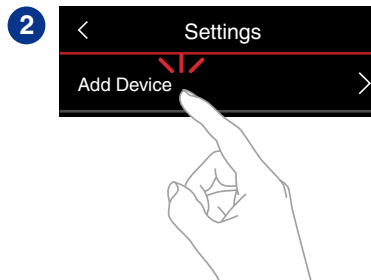
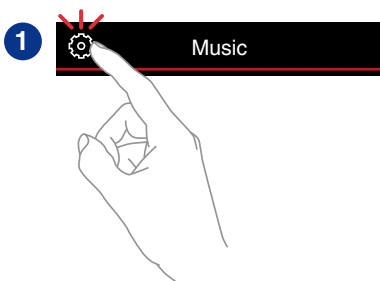

## Using your DHT-S516H for TV

Once you have your DHT-S516H connected to your television and the HEOS app installed on your mobile device, it's easy to start enjoying your television sound.

“Setup Assistant” can be re-executed when changing the TV connection. (🔗 p. 53)

### Connecting to your TV

#### ■ HDMI connection

You can enjoy high quality audio and video playback by connecting this unit and a TV or this unit and a device such as a Blu-ray Disc recorder or game console using a HDMI cable to transmit high resolution digital video signals and Blu-ray Disc audio signals.

- ARC (Audio Return Channel) function

The TV audio can be played back through this unit using the HDMI cable used to connect this unit to the TV (\*1).

\*1 The TV also needs to be compatible with the ARC function.

- HDMI control function

You can switch off the power, switch input source and adjust the volume of this unit using the TV (\*2) remote control.

\*2 The TV also needs to be compatible with the HDMI control function. This function may not operate due to connected devices or settings.

#### ■ Setting the HDMI control function

When the connection to the TV is the same as 1) or 2), enable the HDMI control function on the TV.

If the TV is compatible with the ARC function, enable the ARC function on the TV.

(See the TV Owner's Manual for details.)



## ■ Disable your television's speakers

When the connection to the TV is the same as 3) – 4), disable your television's built-in speakers when using DHT-S516H. Usually, this is done with an on-screen setup menu on your television. Look for an "Audio" or "Sound" sub-menu, and a "Speakers Off", "Disable Speakers", "External Speakers" or similar menu item. Some televisions have a switch on the rear panel to disable the built-in speakers.

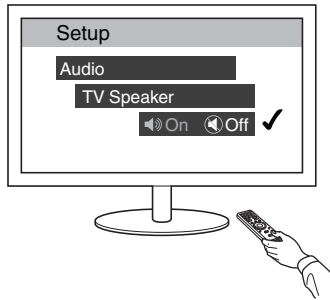

## 1) Playing HDMI (ARC) - Best choice

If your television has an ARC (Audio Return Channel) HDMI connector, connect it to the HDMI output of the DHT-S516H. This will provide the best sound and several other benefits.

- 1** Connect your television with an ARC (Audio Return Channel) HDMI connector to the HDMI OUT (ARC) on your DHT-S516H using the included HDMI cable.
- 2** Select “TV” from the music tab.
- 3** Select the name of the DHT-S516H to which you connected the television in step 1.

The sound from your television can be played directly on the DHT-S516H.

### NOTE

- The TV also needs to be compatible with the ARC function.  
Turn the TV HDMI control function on. See the TV Owner’s Manual for details.

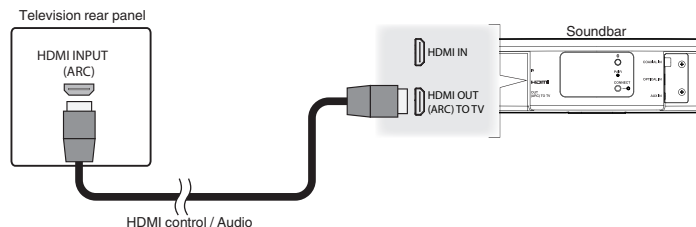



## 2) Playing HDMI (without ARC) - Better choice

Connect to a TV that is not compatible with the ARC (Audio Return Channel) function using the HDMI cable and audio input cable.

- 1** Connect your television with an HDMI connector to HDMI OUT (ARC) on your DHT-S516H using the included HDMI cable.
- 2** Connect your television to your DHT-S516H using either an included optical cable or a digital coaxial cable (not included).
- 3** Select “TV” from the music tab.
- 4** Select the name of the DHT-S516H to which you connected the television in step 1 and 2.

The sound from your television can be played directly on the DHT-S516H.

### NOTE

- The TV audio cannot be played back on this unit when it is only connected with the HDMI cable.

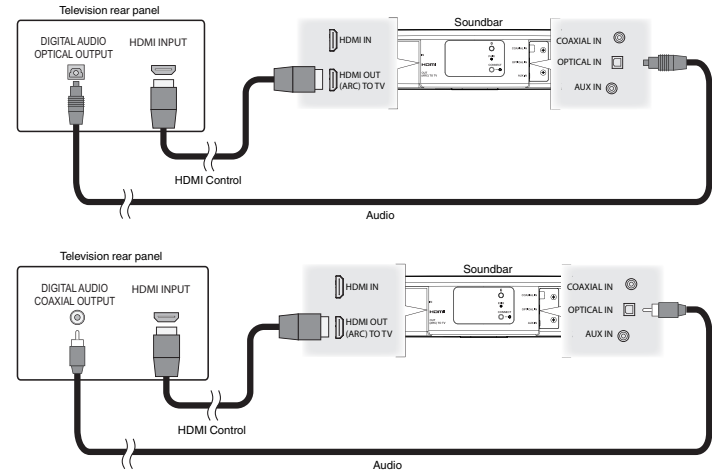

### 3) Playing digital optical input - Good choice

A optical cable connection from the television also provides excellent sound.

- 1** Connect your television with an optical output to the **OPTICAL IN** on your DHT-S516H using the included Optical cable.
- 2** Select “TV” from the music tab.
- 3** Select the name of the DHT-S516H to which you connected the television in step 1.

The sound from your television can be played directly on the DHT-S516H.

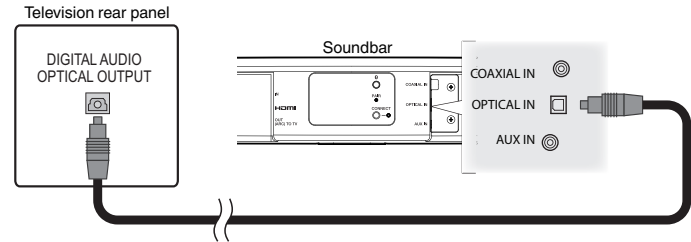

The optical connector looks square, but it is “keyed” and will only plug in one way; don’t force it.



## 4) Playing digital coaxial input - Good choice

Another way to supply a digital audio signal to the DHT-S516H.

- 1** Connect your television with an optical output to the **COAX IN** on your DHT-S516H using an “RCA” type cable (not included).
- 2** Select “TV” from the music tab.
- 3** Select the name of the DHT-S516H to which you connected the television in step 1.

The sound from your television can be played directly on the DHT-S516H.

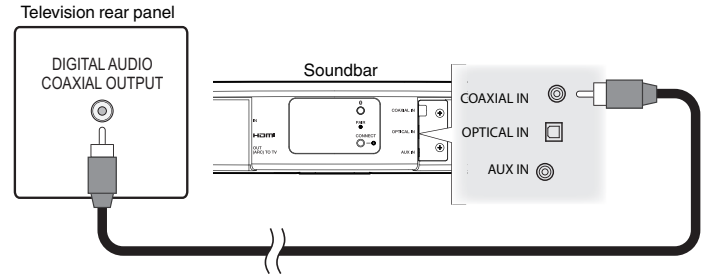

## Connecting DHT-S516H to your HDMI equipment

Connect an HDMI device such as a Blu-ray player to the HDMI IN terminal on your DHT-S516H.

HDMI equipment rear panel

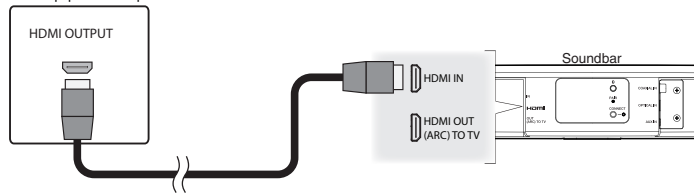

### NOTE

- DTS audio can not be passed from your TV over an optical connection so it is recommended to connect your Blu-ray player to the HDMI IN terminal on the DHT-S516H to enjoy DTS encoded discs.

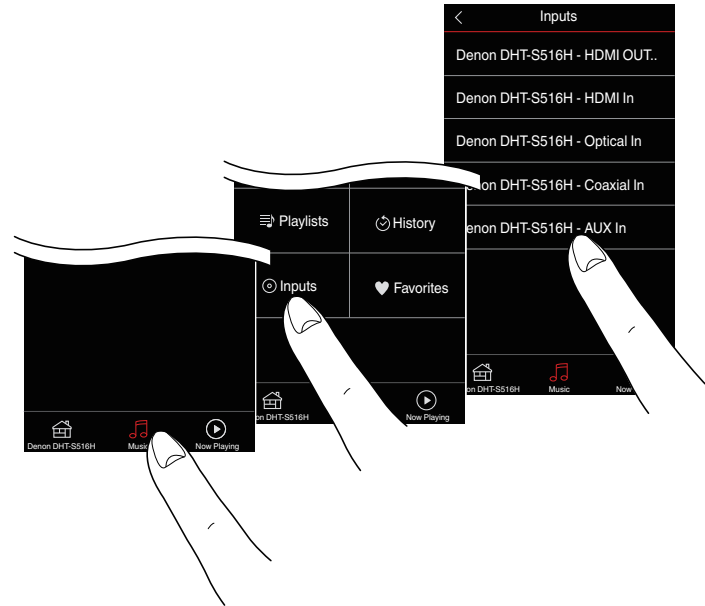

## Listening to TV Audio

Once you have connected your DHT-S516H to your TV, and setup the TV input you are ready to enjoy sound from your TV. (👉 p. 53)

**1** Tap the “Music” tab.

**2** Tap “TV”.

### ■ Adjusting the dialog sound

The Dialog enhancer highlights center-recorded sounds such as movie dialog, television announcers, or musical soloists; it is valuable for everyday television viewing.

### ■ Listening at night

The night mode improves low-volume listening by subtly lifting softer sounds, and lowering very loud ones. While you may use the night mode whenever you like, for maximum dynamic realism from television programming, movies, or music, leave the night mode turned off.

### ■ Adjusting sound mode

You can select the sound mode either “MOVIE” or “MUSIC”. The movie mode deploys DHT-S516H’s maximum processing for the “biggest” possible sound on action films or other large-scaled content. The music mode widens the “soundstage” somewhat for a more enveloping, involving sound.

### ■ Checking the audio status

You can check the input and signal format by pressing the ⓘ at the left top area.

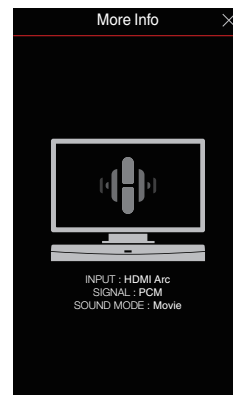

## Using your DHT-S516H for music

Once you have your HEOS device connected to your network and the HEOS app installed on your mobile device, it's easy to start enjoying your favorite music. You can listen to something different on every HEOS device or the same music perfectly synchronized on all HEOS devices. It's up to you!

### Selecting a room/speaker

If you have more than one HEOS device, you must tell the HEOS system which HEOS device you want to control:

- 1 Tap the “Rooms” tab.
- 2 Select the Room/Speaker you want to control.
- 3 Select the “Music” tab to select a music source or the “Now Playing” tab to control what is currently playing in the selected room.

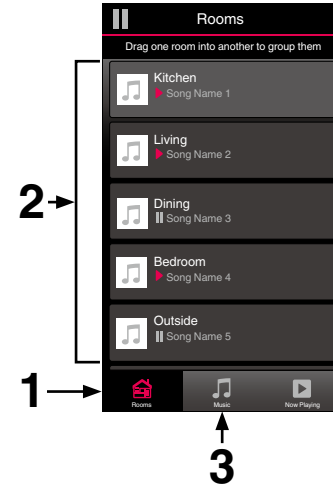

## Listening to radio

The HEOS system includes access to more than 100,000 free internet radio streams from all corners of the globe via the TuneIn radio service. Just select the TuneIn logo from the main “Music” menu and browse among the 100,000 stations neatly organized into popular categories and select a station that appeals to your mood.

### NOTE

- If you have a TuneIn account, you can sign into the TuneIn service under Settings - Music Sources - TuneIn, and access all of your “My Favorites” TuneIn stations.

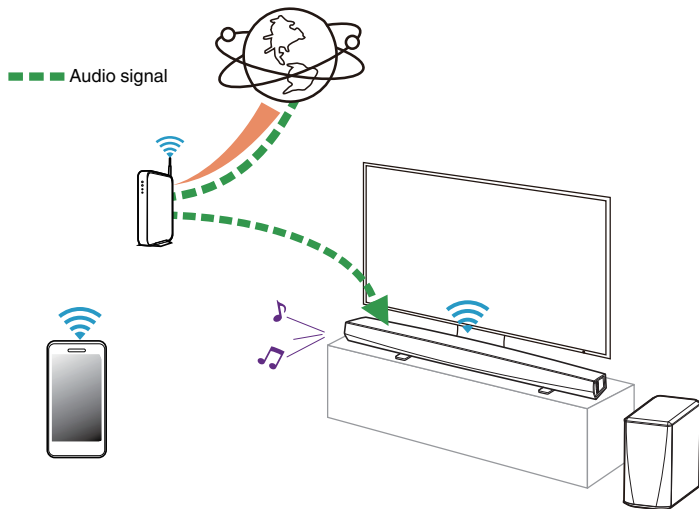

## Playing music stored on your mobile device

- 1 Tap the “Music” tab.
- 2 Select “This iPhone/iPod/iPad/Phone”.
- 3 Browse the local music on your phone and select something to play.

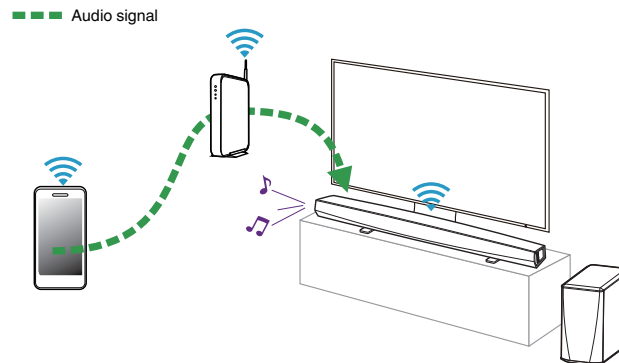

## Playing music from your networked PC or NAS

- 1 Select “Music Servers” from the “Music” tab.
- 2 Select the name of your networked PC or NAS (Network Attached Storage) server.
- 3 Browse the music on your PC/NAS and select something to play.

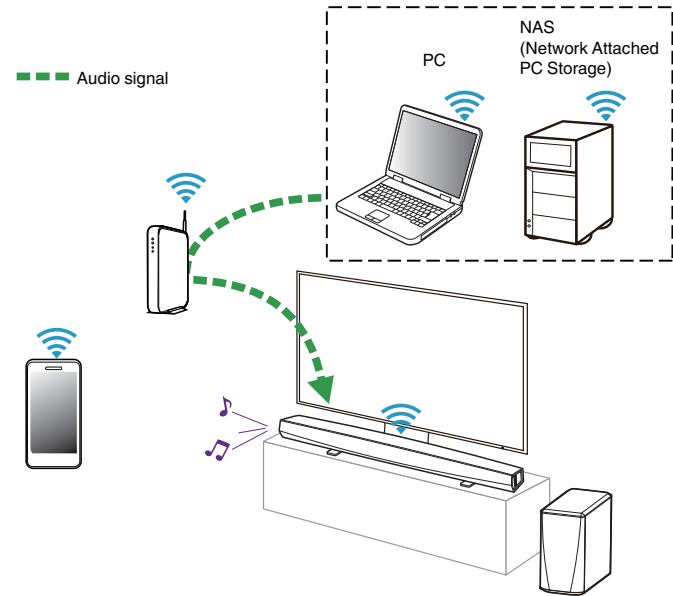



## Playing music from a USB device

- 1** Insert a FAT32 formatted USB device into the USB port on the back of the HEOS speaker.
- 2** Select “USB Music” from the Music tab.
- 3** Select the name of your HEOS speaker.
- 4** Browse the music on your USB device and select something to play.

### NOTE

- It may take several minutes for the name of your HEOS device to appear in the “USB Music” list if you have a large number of files on your USB device.
- It is not possible to connect and use a computer via the USB port of this unit using a USB cable.

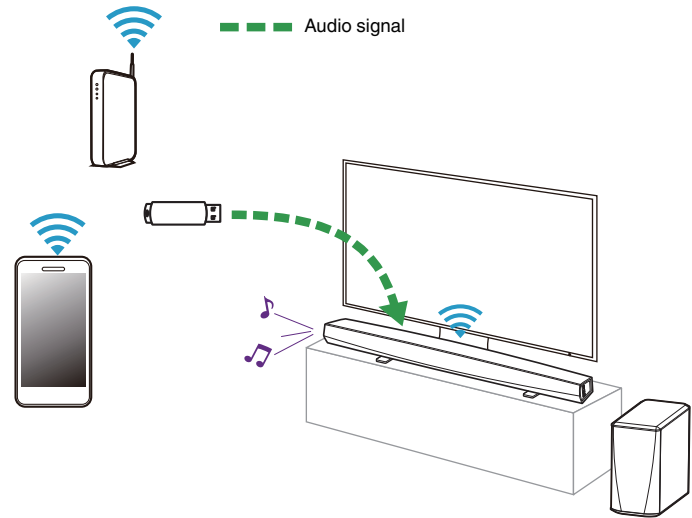

## Playing music from Bluetooth device

### ■ Pairing the HEOS device with your Bluetooth devices

- 1 Activate the Bluetooth setting on your mobile device.
- 2 Press and hold the Bluetooth button (📶) located on the back of the DHT-S516H for 3 seconds and release the button when you see a pattern of two green flashes on the status LED.
- 3 Select “Denon DHT-S516H” from the list of available Bluetooth devices.  
In a few seconds your mobile device will indicate that it is connected to your DHT-S516H.
- 4 Play music using any app on your device. The sound will now play from the DHT-S516H.

#### NOTE

- Disconnect and reconnect Bluetooth connections from your Bluetooth device.

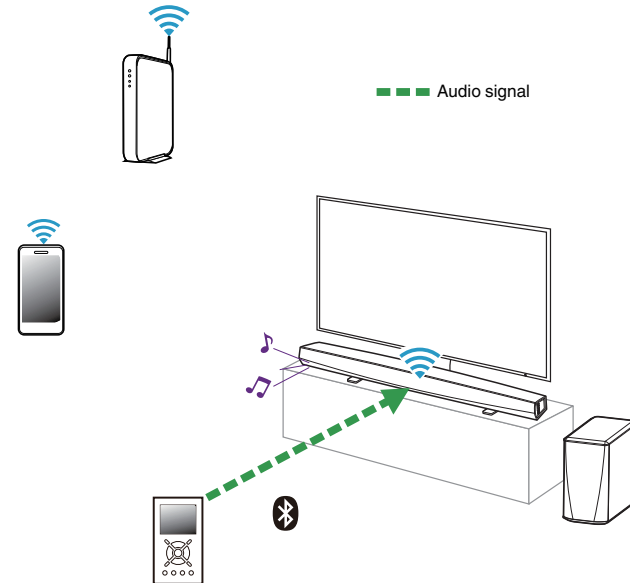

## Playing music from the AUX input

The sound from the audio device can be played directly on the selected speaker or digitized and sent over your network to other speakers.

- 1 Connect an audio device with a 3.5 mm stereo audio output to the AUX input on your speaker using the included 3.5 mm stereo audio cable.**

When a stereo audio cable is connected to AUX IN, the source automatically switches to Inputs.

### NOTE

- When there is a cable connected to AUX IN, select "Inputs" from the Music tab.

- 2 Initiate playback on the audio device.**

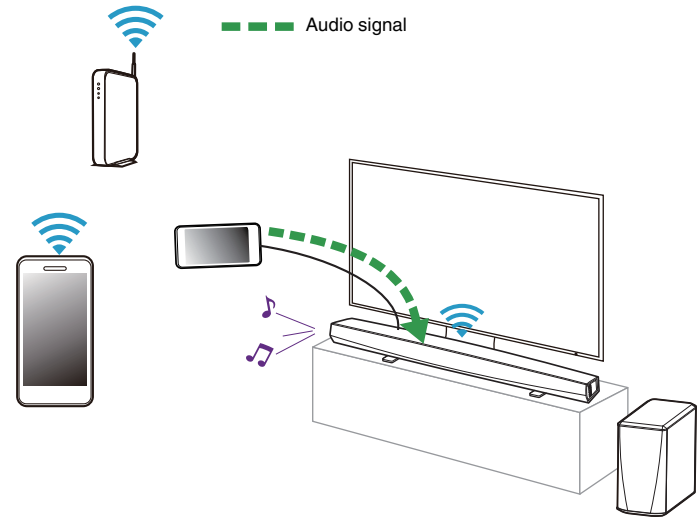

## Managing AUX inputs

If you connected external audio source components to any of your HEOS speakers AUX inputs, you can rename the default input names to describe the actual source or hide any inputs that are not being used.

- 1** Select the **Settings**  icon located in the upper left corner of the main “Music” menu to display the Settings menu.
- 2** Select “Music Sources”.
- 3** Select “Inputs”.
- 4** Select the speaker which you connect your external audio source device to.

### ■ Changing the name of the AUX inputs

- 1** Select “AUX In”.
- 2** Select “Name”.
- 3** Select or enter a new name to describe the source that you connected.
- 4** Select the Save button to save your changes.

### ■ Hiding an AUX input

- 1** Select “AUX In”.
- 2** Toggle “Hide Input” to ON to prevent this AUX input from appearing under the Inputs tile on the main Music menu.



## Managing your phone

Your smartphone or tablet can be hidden if it does not need to be in the “Music Sources” menu.

- 1** Select the **Settings**  icon located in the upper left corner of the main “Music” menu to display the Settings menu.
- 2** Select “Music Sources”.
- 3** Select “This iPhone/iPod/iPad/Phone”.
- 4** Toggle “This iPhone/iPod/iPad/Phone” to OFF to prevent the service logo from appearing on the main “Music” menu.



## HEOS account

### ■ What is a HEOS account?

A HEOS account is master account or “keychain” for managing all of your HEOS music services with one single username and password.

### ■ Why do I need a HEOS account?

With the HEOS account you just have to enter your music services login names and passwords one time. This allows you to easily and quickly use multiple controller apps on different devices. You just log into your HEOS account on any device and you will have access to all of your associated music services, play history and custom playlists, even if you are at a friend’s house listening to music on their HEOS system.

### ■ Signing up for a HEOS account

You will be instructed to signup for a HEOS account the first time you try to access any music service from the main “Music” menu of the HEOS app.

### ■ Changing your HEOS account

- 1 Tap the “Music” tab.
- 2 Select the Settings  icon in the upper left corner of the screen.
- 3 Select “HEOS Account”.
- 4 Change your location, change your password, delete your account or sign out of your account.



## Playing from streaming music services

A music service is an online music company that provides access to vast music collections via free and/or paid subscriptions. Depending upon your geographical location, there are several options to choose from.

### NOTE

- The HEOS app and brand is not affiliated with any manufacturer of any mobile device. Availability of music services may vary by region. Not all services may be available at time of purchase. Some services may be added or discontinued from time to time based on decisions of the music service providers or others.

## ■ Adding a music service

Once you've setup your HEOS account, you can add supported music services to your HEOS system by tapping on the music service logo in the "Music" tab.

Follow the instructions on the screen to add your username and password for the selected music service. You only have to enter your account information once as the HEOS account service will securely remember your login information so you don't have to enter it each time you want to play music from the music service.

Additional music services may be available under "Settings" - "Music Sources" - "Online Music".

## ■ Changing music service settings

- 1 Tap the "Music" tab.
- 2 Select the Settings  icon in the upper left corner of the screen.
- 3 Select "Music Sources".
- 4 Select "Online Music".
- 5 Select the name of the online music service you want to edit.
- 6 Sign out, then sign in again to associate your username and password with your HEOS account.
- 7 Select "Hide for Now" to prevent the service logo from appearing on the main "Music" menu.



## Listening to the same music in multiple rooms

The HEOS system is a true multiroom audio system that automatically synchronizes audio playback between multiple HEOS devices so that the audio coming from different rooms is perfectly in sync and always sounds amazing!

You can easily add up to 32 HEOS devices to your HEOS system.

You can join or group up to 16 individual HEOS devices into a group of HEOS devices that function as if they were a single HEOS device.

### ■ Grouping rooms

- 1** Press and hold your finger on room that is not playing music.
  - 2** Drag it into the room that is playing music (indicated by the red outline) and lift your finger.
- The two rooms will be grouped together into a single device group and both rooms will be playing the same music in perfect sync.

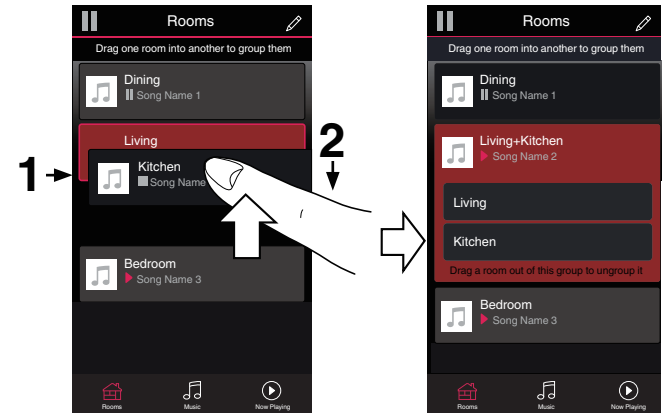

- Grouping cannot be used when this unit is playing TV audio or external input audio. Enable “TV Sound Grouping” to use grouping. (🔗 p. 54)





## ■ Ungrouping rooms

**1** Press and hold your finger on room that you want to remove from the group.

**2** Drag it out of the group and lift your finger.

Music will stop playing in the room you dragged out of the group but will continue playing in any remaining rooms.

### NOTE

- You can not remove the first room that started playing the music before grouping.

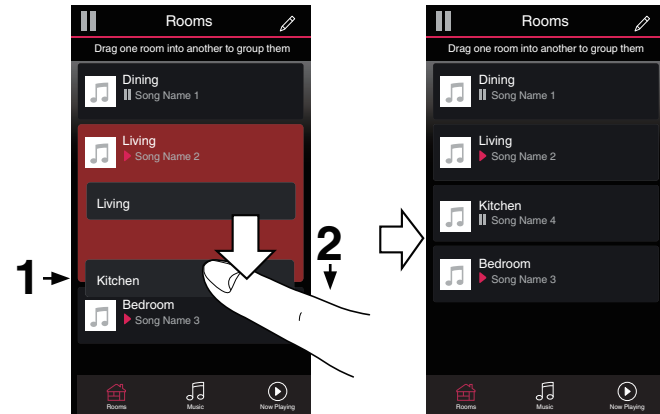

## ■ Grouping all rooms (party mode)

You can easily group 16 rooms together into Party Mode by using a “pinch” gesture.

**1** Place two fingers on the screen over the list of rooms.

**2** Quickly pinch your two fingers together and release.

All of your rooms will be joined together and begin playing the same music in perfect sync.

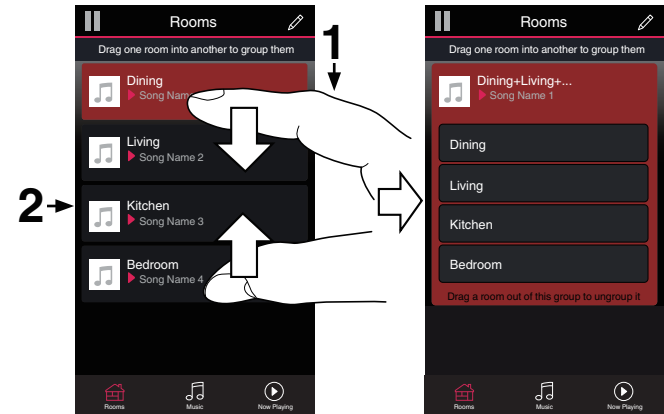

## ■ Ungrouping all rooms

You can easily ungroup all of your rooms and exit Party Mode by using a “spread” gesture.

- 1 Place two fingers close together on the screen over list of rooms.**
- 2 Quickly spread your two fingers apart from each other and release.**

All of your rooms will be ungrouped and music will stop playing in every room (except the original “master” room that was playing before you grouped the rooms together).



## Using the now playing queue

HEOS uses a Now Playing “Queue” to line up music that you want to listen to. Music can be selected from any of your local or online music sources (as long as they are not preprogrammed “radio” or “station” type streams). This feature works similarly to how a jukebox works. You select something to play (a song, album, playlist or even your entire music collection) and add it to the “Queue”. When you select something to play you will be asked how you want to queue up your music.

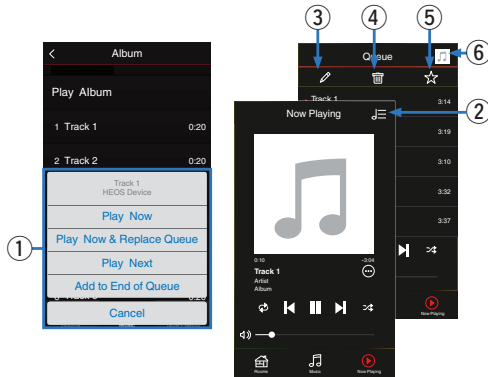

### 1 Queue Menu

When you select something to play you will be asked how you want to queue up your music.

### 2 Queue icon

### 3 Pencil icon

### 4 Delete icon

### 5 Save icon

### 6 Cover art or HEOS icon

You can return to the Now Playing screen display by tapping the cover art or the HEOS icon.

### ■ Play Now

Inserts the item into the queue after the currently playing track and plays the selected item immediately.

### ■ Play Now & Replace Queue

Clears the queue and plays the selected item immediately.

### ■ Play Next

Inserts the item into the queue after the current song and plays it when the current song ends.



### ■ Add to End of Queue

Adds the item to the end of the queue.





## Rearranging the now playing queue

Once you have songs lined up in your queue, you might want to rearrange the order or remove some songs:

- 1 Tap the “Now Playing” tab.
- 2 Tap the Queue  icon in the upper right corner of the screen.
- 3 Tap the Pencil  icon to enter Edit mode.
- 4 Rearrange the order of your queue by dragging the list  icon (on the right side of each track row) up or down.

## Deleting songs from the play queue



You can remove songs one at a time from the Now Playing Queue:

- 1 Tap the “Now Playing” tab.
- 2 Tap the Queue  icon in the upper right corner of the screen.
- 3 Tap the Pencil  icon to enter Edit mode.
- 4 Tap the track(s) that you want to delete.
- 5 Tap the Delete  icon to delete all of the selected tracks from the play queue.





## Deleting all songs from the play queue

You can remove all of the songs from the Now Playing Queue:

- 1 Tap the “Now Playing” tab.
- 2 Tap the Queue  icon in the upper right corner of the screen.
- 3 Tap the Delete  icon to confirm that you want to delete all songs from the queue.



## Saving playlists

You can save the Now Playing Queue as a HEOS Playlist that you can recall later. The new playlist will be available from the Playlists button on the “Music” tab on every controller app connected to your HEOS system.

- 1 Tap the “Now Playing” tab.
- 2 Tap the Queue  icon in the upper right corner of the screen.
- 3 Tap on the Save  icon.
- 4 Enter a name for your Playlist and tap the Save  icon.

## Performing repeat and shuffle playback

The playback controls are visible on the “Now Playing” screen.

- 1 Tap the “Now Playing” tab.
- 2 Tap the repeat  and shuffle  controls.



## Using the favorites

HEOS uses a "HEOS Favorites" to line up station you want to start play quickly the favorite stations. Station can be selected from online music sources such as "Radio" or "Station" type streams. "HEOS Favorites" will display a list of the stations of various services.

### ■ Adding to HEOS Favorites

Inserts the item into the queue after the currently playing track and plays the selected item immediately.



Select a station of an online music source. When the action menu screen is displayed, select "Add Station to HEOS Favorites".

#### NOTE

- This can also be done by selecting "Add Station to HEOS Favorites" from the station menu of the station being played.

### ■ Deleting station from the HEOS favorites

Inserts the item into the queue after the currently playing track and plays the selected item immediately.

- 1 Tap the "Music" tab.
- 2 Select "Favorites".
- 3 Tap the Pencil  icon to enter Edit mode.
- 4 Tap the delete  icon that you want to delete station.
- 5 Tap the "Delete" that you want to delete station.



## AirPlay function

Music files stored on your iPhone, iPod touch, iPad or iTunes can be played on this unit via the network.

### NOTE

- The screen may differ depending on the OS and software versions.

### This device supports AirPlay 2®.

Sync multiple AirPlay 2 compatible devices/speakers for simultaneous playback.



- This unit supports AirPlay 2 and requires iOS 11.4 or later.

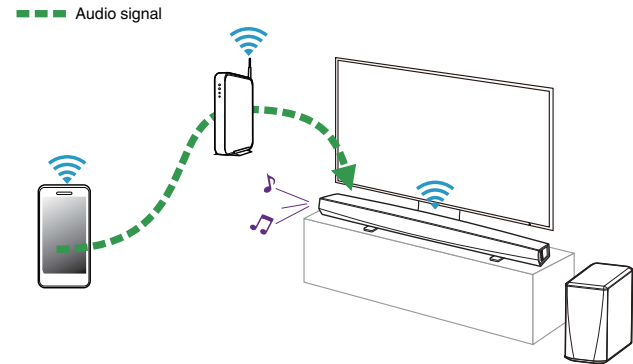



## Playing songs from your iPhone, iPod touch or iPad

If you update your “iPhone/iPod touch/iPad” to iOS 4.2.1 or later, you can stream music stored in your “iPhone/iPod touch/iPad” directly to this unit.

### 1 Connect your iPhone, iPod touch or iPad Wi-Fi to the same network as this unit.

- For details, see your device’s manual.

### 2 Play the song on your iPhone, iPod touch or iPad.

AirPlay icon is displayed on the iPhone, iPod touch or iPad screen.

### 3 Tap the AirPlay icon.

[Example] iOS 10



[Example] iOS 9



### 4 Select the speaker (devices) you want to use.

## Playing iTunes music with this unit

### 1 Install iTunes 10, or later, on a Mac or Windows PC that is connected to the same network as this unit.

### 2 Start iTunes and click the AirPlay icon to select the main unit.

[Example] iTunes



### 3 Choose a song and click play in iTunes.

The music will stream to this unit.



## Play a song from your iPhone, iPod touch or iPad on multiple synced devices (AirPlay 2)

Songs from an iPhone, iPod touch or iPad operating iOS 11.4 or later can be synced with multiple AirPlay 2 supported devices for simultaneous playback.

### 1 Play the song on your iPhone, iPod touch or iPad.

AirPlay icon is displayed on the iPhone, iPod touch or iPad screen.



### 2 Tap the AirPlay icon.

Displays a list of devices/speakers that can be played back on the same network.

- A circle is displayed to the right of AirPlay 2 compatible devices.

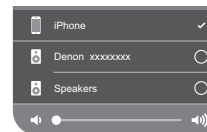

### 3 Tap the devices/speakers you want to use.

- Multiple AirPlay 2 compatible devices can be selected.
- Volume can be adjusted for each device individually or for all synced devices simultaneously.



## Making speaker adjustments

You can adjust specific settings for each of your DHT-S516H in your system:

- 1** Select the **Settings**  icon located in the upper left corner of the main “Music” menu to display the Settings menu.
- 2** Select “My Devices” to display a list of your HEOS devices.
- 3** Select the DHT-S516H you want to adjust.

### Changing the name

- 1** Select “Name”.
- 2** Select or enter a new name for your DHT-S516H.
- 3** Tap the  icon to save your changes.

### Changing the wireless network connection

- 1** Select “Network”.
- 2** A list of wireless networks that your DHT-S516H can access is displayed.
- 3** Select the network you want your DHT-S516H to join.  
Wait as the DHT-S516H’s network connection is changed.

#### NOTE

- Wired networking is automatically selected when the speaker is connected to a wired Ethernet network. To switch back to using a wireless network you must remove the Ethernet cable from the back of the DHT-S516H.



## Changing the equalizer and subwoofer level

- 1 Select “EQ”.
- 2 Adjust the Treble, Bass or Subwoofer level up or down.

## Adjusting the audio quality

Selects the transcoding option for rebroadcasting audio from one HEOS device to another HEOS device (or group of devices) across the network. When set to “Normal”, high bit rate audio sources originating from the first device (such as AUX input, WAV, FLAC and PCM) will be transcoded to ensure the highest level of reliability for the audio stream.

- 1 Select “Quality”.
- 2 Select “Normal” (default) or “High”.



- If you have selected “High” and you experience audio dropouts when streaming sources from one device to other devices, please select “Normal” (default).
- This setting does not affect the AUX input when played on the connected device by itself (there are no other devices grouped to it), in which case the original source quality and bit rate are maintained and there is no inherent delay.



## Adjusting the status light brightness

- 1 Select "Status Light".
- 2 Adjust the brightness up or down or set the slider to the OFF position to completely disable the status light.

## Locating the Soundbar

- 1 Select "Placement".
  - Wall Mount**  
Attach the soundbar on the wall.
  - Table**  
Place the soundbar on the table.

## Changing the TV connection

"Setup Assistant" can be re-executed when changing the TV connection.

- 1 Select "Setup Assistant".
- 2 Turn on your TV.
- 3 Select which input you want to use to connect your TV.

## Setting the TV Input and Auto-Play

- 1 Select "TV Input".
- 2 Select "Default Input".
- 3 Select new default input.

### Auto-Play

---

When Auto-Play is enabled, the DHT-S516H switches to the Default Input as the audio source. If streaming music playback is stopped.

---



## Controlling your DHT-S516H

DHT-S516H can be operated using the remote control unit of the TV.

- 1 Select “Remote Control”.**  
The setup below is not required when device control by HDMI is active. (A check mark will be displayed by “HDMI CEC” in this case)
- 2 Select “IR Control”.**
- 3 Select a DHT-S516H command you would like to control by your remote controller.**

## TV Sound Grouping

Set when you want to play TV audio or external input audio from this unit through a different HEOS device.

- 1 Select “TV Sound Grouping”.**

**Enable**

Enables grouping.

**Audio Delay**

Sets the delay for the audio.

### NOTE

- The audio may cut out if the amount of delay is too short. Lengthen the amount of delay if the audio cuts out.



## Advanced settings

### Caution

- Adjusting these settings may disconnect your DHT-S516H from your network and possibly render your DHT-S516H unusable. Do not use these features unless you are comfortable making advanced adjustments to your DHT-S516H.

## ■ Network settings

- 1** Select “Advanced”.
- 2** Select “NETWORK SETTINGS” tab.
- 3** Scroll down to see all of the options for
  - a. Network Interface (Ethernet or Wireless)
  - b. Wireless Settings
  - c. IP Address Settings (Automatic or Manual)
  - d. Wireless Power Saving
- 4** Select “Save Settings” to apply the new settings or “Cancel Changes” to revert to the previous settings.

## ■ About wireless power saving

The Wireless Power Savings feature saves power by turning off power to the wireless radio inside the HEOS device when the device is connected to an Ethernet network. If you disconnect the Ethernet cable from the HEOS device, Wireless Power Saving will automatically turn off and the wireless radio will turn on so that the HEOS device can be discovered over your wireless network.

### NOTE

- If Wireless Power Savings is ON, Wi-Fi power will be temporarily turned on when accessing the My Devices - (My Devices) - Network screen in the HEOS app or whenever the Connect button on the device is pressed.



## ■ Firmware upgrade

- 1 Select “Advanced”.
- 2 Select “FIRMWARE UPDATE” tab.
  - Update status

---

  - Manually check for a firmware upgrade.

---

  - Allow updates

---

  - ON  
(Default): Allows updates

---

  - OFF: Does not allow updates

---
- 3 Select “Save Settings” to apply the new settings or “Cancel Changes” to revert to the previous settings.

## ■ About

Viewing technical details about the HEOS device.

- 1 Select “Advanced”.
- 2 Select “ABOUT” tab.
- 3 Scroll down to see information about the speaker’s.
  - a. Hardware
  - b. Software
  - c. Device





## Updating your system

---

HEOS has the ability to add enhancements and updated functionality via your high speed Internet connection. Follow the instructions on the screen to update the HEOS device and/or your controller App.

**1** Select the Settings  icon located in the upper left corner of the main “Music” menu to display the Settings menu.

**2** Select “Software Update”.

### Check for Update

Follow the instructions on screen to install any available updates to your HEOS system.

### Auto-Update

<b>ON</b> (Default):	Valid updates are performed automatically.
<b>OFF:</b>	You will be notified of valid updates on the HEOS app.



## Advanced features

There are a few advanced features of the HEOS system that you may want to explore once you become familiar with the basic operations. You can access the advanced features of the HEOS system by following these steps:

- 1** Select the **Settings**  icon located in the upper left corner of the main “Music” menu to display the **Settings** menu.
- 2** Select “**Advanced Settings**” to display a list the available settings.

### Wireless performance

You can check the wireless connection status of your HEOS device.

#### Quality

---

**Excellent / Good / Poor**

---

#### NOTE

- If the quality level of your HEOS device is “Poor”, make sure your HEOS devices are not located near other electronic devices that could interfere with its wireless connectivity (like microwave ovens, cordless phones, TVs, etc...)

#### Signal

---

**Excellent / Good / Poor**

---

#### NOTE

- If the signal level of your HEOS device is “Poor”, make sure your HEOS devices are within range of your wireless network.



## Pairing the soundbar and subwoofer

The subwoofer and soundbar are paired at the factory. However if the communication is interrupted, follow this procedure.

### 1 Press the “PAIR” Button on the subwoofer until the Status LED flashes blue.

The soundbar power is turned on.

### 2 Press the “PAIR” Button on the back of the soundbar.

The Status LED on the subwoofer will be solid blue.

#### Status LED

<b>Amber LED:</b>	Subwoofer is not paired to soundbar.
<b>Blue LED:</b>	Subwoofer is paired to soundbar. Your system is ready.



# Power management

## Power modes

### ■ Quick Start Mode

HEOS device automatically enters "Quick Start Mode" to save power in the following cases. This unit will automatically resume to full power whenever the device is selected and playing music.

The status LED dims when the mode is switched to Quick Start Mode.

### □ Ethernet

After around 20 minutes of no operation and no network access after playing music via Ethernet.

### □ Wi-Fi

After around 20 minutes of no operation and no network access after playing music via Wi-Fi.

### □ USB

After around 20 minutes of no operation and no network access after playing music from a USB memory device.

### □ Bluetooth

After the Bluetooth connection is disconnected and there is around 20 minutes of no operation and no network access after playing music via Bluetooth.

### □ AUX IN

After around 20 minutes of no operation after AUX cable is disconnected.

### □ OPT IN

After around 20 minutes of no operation after optical device is put into standby.

### □ COAX IN

After around 20 minutes of no operation after coaxial device is put into standby.

### □ HDMI IN

Play the HDMI device, such as a Blu-ray player, connected to this unit. Around 20 minutes after HDMI device and TV are put into standby.

### □ HDMI OUT (ARC)

Connect this unit and the ARC compatible TV with HDMI cable and play TV. Around 20 minutes after TV is put into standby.



## ■ Deep Standby

The device also has the ability to automatically enter “Deep Standby” whenever the wired or wireless network connection is removed for more than 60 minutes in “Quick Start Mode”.

The front panel LED will turn off during Deep Standby. To “wake” a DHT-S516H from Deep Standby,

- Press the volume or mute buttons.
- Input audio signal to Optical/Coaxial.
- CEC (Consumer Electronics Control) command over HDMI/ARC
- Press the button on your remote controller which you taught DHT-S516H by “Controlling your DHT-S516H”.

### NOTE

- It may take around 40 seconds to wake up your DHT-S516H from the deep standby.



- You also push the mute button for 3 seconds, the device enters the Deep Standby.

## ■ Off

To completely turn off the power to the device you must remove the mains plug from the power outlet.



## Basic troubleshooting

### No sound

Solution	Refer to Page
<ul style="list-style-type: none"> <li>Is DHT-S516H's volume turned up? (Don't laugh; we do this one ourselves all the time.)</li> </ul>	—
<ul style="list-style-type: none"> <li>Is DHT-S516H muted (if so, the front LED is slowly blinking.)</li> </ul>	—
<ul style="list-style-type: none"> <li>Is the audio source a volume-controlled television or cable/satellite box output? If so, you must turn up the volume of the television or cable/satellite box to send adequate signal-level to DHT-S516H. (For this reason it is best to choose fixed-level outputs where possible; some televisions have separate physical outputs, other employ on-screen menu settings to manage this.)</li> </ul>	—
<ul style="list-style-type: none"> <li>Check connections: remember that DHT-S516H auto-prioritizes multiple incoming signals, selecting HDMI, optical-digital, coaxial-digital, and analog-mini plug, in that order. Confirm that the television is routing audio to the appropriate output; there may be TV-menu settings to manage this.</li> </ul>	—

### No subwoofer sound, sound interrupted, or noise occurring

Solution	Refer to Page
<ul style="list-style-type: none"> <li>Check that the Status LED is lit in blue on the subwoofer. When the Status LED is lit in amber, disconnect from the wall outlet and then reconnect to it, or try to pair again.</li> </ul>	59
<ul style="list-style-type: none"> <li>When there is an obstacle between the soundbar and the subwoofer, remove it or place the subwoofer closer to the soundbar.</li> </ul>	—



## Distorted sound from the DHT-S516H

Solution	Refer to Page
<ul style="list-style-type: none"> <li>• If the signal source is a volume-controlled output, turn it down a couple of steps from maximum.</li> <li>• Check the signal source to be sure the distortion is not originating there.</li> <li>• If DHT-S516H's volume is set to its maximum, turn it down a few steps.</li> </ul>	<p>—</p> <p>—</p> <p>—</p>

## Trouble teaching DHT-S516H remote control commands

Solution	Refer to Page
Remember that while DHT-S516H can learn almost all IR (infrared) remote commands, there remain a few rare code formats that cannot be taught (much like some engineers we know).	—

## Television speakers keep getting turned back up

Solution	Refer to Page
Disable the television's speakers (usually a setup-menu option, but a rear-panel switch on some televisions). If this is not possible, the problem is likely that the television responds to press-and-hold (ramping) volume commands more quickly than the DHT-S516H; in this rare case use DHT-S516H's front-panel or supplied remote to turn the DHT-S516H's volume up.	—



## My speaker won't connect to my network using the audio cable

Solution	Refer to Page
<ul style="list-style-type: none"> <li>• Make sure your mobile device is connected to your wireless network before setting up your speaker.</li> </ul>	20
<ul style="list-style-type: none"> <li>• Alternatively, you can connect your speaker to your network router using the included Ethernet cable. Once connected via Ethernet, the HEOS App should recognize the speaker and you can manually move it to your wireless network using Settings/My Devices/Device_Name/Advanced/Network Settings.</li> </ul>	21

## Music cuts out or delays sometimes

Solution	Refer to Page
<ul style="list-style-type: none"> <li>• Make sure your Internet connection is operating correctly. If you are sharing your network with other users or devices, they may be using most of your bandwidth (especially if they are streaming video).</li> </ul>	7
<ul style="list-style-type: none"> <li>• Make sure your speakers are within range of your wireless network.</li> </ul>	58
<ul style="list-style-type: none"> <li>• Make sure your speakers are not located near other electronic devices that could interfere with it's wireless connectivity (like microwave ovens, cordless phones, TVs, etc...).</li> </ul>	58





## I hear a delay when using the external input with my TV

Solution	Refer to Page
<ul style="list-style-type: none"> <li>If you are connecting the External input with your cable or satellite box for enjoying TV audio through multiple HEOS devices, you may hear a delay between when you see someone speak and when you hear the audio. This is because the HEOS system must buffer the audio before it sends it out to the HEOS devices so that it arrives at all devices at the same time.</li> <li>You can avoid this delay by listening only to the device which is directly connected to the set top box.</li> </ul>	<p>—</p> <p>—</p>

## Connecting to a network using an iOS device

Solution	Refer to Page
<p>This HEOS device supports Apple's "WAC (Wireless Accessory Configuration)" setup mode. WAC setup mode allows you to connect your HEOS device to your network without requiring you to type in the network name and password.</p> <ol style="list-style-type: none"> <li>The LED on the rear of the HEOS device will slowly blink amber to indicate that WAC setup mode is active. If the rear LED is not blinking amber, press and hold VOLUME DOWN and MUTE buttons for 3 seconds until you see the LED blinking amber.</li> <li>Go to the Wi-Fi menu under Settings on your iOS device.</li> <li>Select "Denon DHT-S516H" under "SET UP NEW AIRPLAY SPEAKER..." at the bottom of the list.</li> <li>Select the network you want your HEOS device to connect to and select "Next".</li> <li>Follow the instructions on the screen to complete setup.</li> <li>When the connection is complete, the LED on the front of the HEOS device will turn solid blue.</li> </ol> <p>HEOS will stay in WAC setup mode for 15 minutes. If the device is not setup within 15 minutes, it will revert back to its previous network connection. Press the Mute button if you want to cancel WAC setup mode.</p>	<p>—</p>



## Connecting to a WPS network

Solution	Refer to Page
<p>If your wireless router support WPS (Wi-Fi Protected Setup™) your HEOS wireless speaker can optionally connect to your network using the “Push Button” method by following these steps:</p> <p>Wi-Fi Protected Setup™ is trademarks of Wi-Fi Alliance.</p> <ol style="list-style-type: none"> <li>1. Press the WPS button on your router.</li> <li>2. Within 2 minutes, rapidly press the Connect button 3 times (within 2 seconds of each press).</li> <li>3. The LED on the front of the speaker will flash green for several seconds as it connects to your WPS router.</li> <li>4. When the connection is complete, the LED on the front of the speaker will turn solid blue.</li> </ol>	7

## Resetting your speaker

Solution	Refer to Page
<p>Resetting your speaker will clear out the wireless network info, EQ, and name but retain it's current software. You will have to use Settings - Add Speaker to reconnect the speaker to your home network before it can be used.</p> <p>To reset your speaker, press and hold the Connect and Bluetooth buttons located on the back of the HEOS speaker for 5 seconds until the front LED begins to flash amber.</p>	–

## DHT-S516H takes long time to turn on

Solution	Refer to Page
<p>In case the DHT-S516H as in the DEEP standby mode, it may takes around 40 second to turn on.</p>	–



## Status LED table



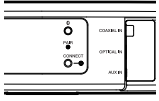
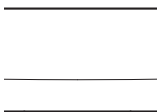
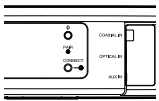
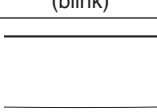
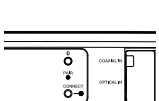
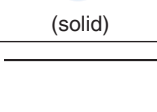
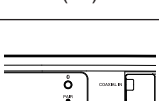

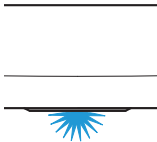
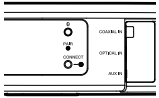
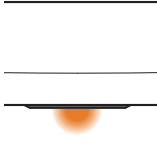
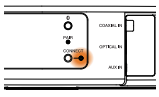
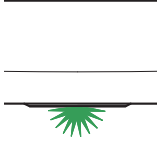
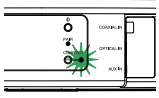
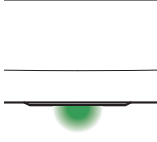
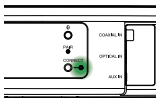

### Soundbar

Device Operation	Description	Front LED Action	Rear LED Action
Off	No AC power or Deep Standby	 (off)	 (off)
Plug in	Booting	 (blink)	 (off)
On	Ready-Configured and connected to your network	 (solid)	 (off)
On	Not Connected to your network	 (solid)	 (solid)

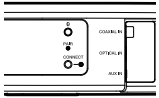

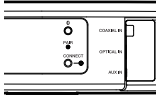
Device Operation	Description	Front LED Action	Rear LED Action
Change Network	Connecting to your network	 <p>(blink)</p>	 <p>(off)</p>
Setup	Not connected	 <p>(solid)</p>	 <p>(solid)</p>
	Connect button was pressed	 <p>(blink)</p>	 <p>(blink)</p>
	Cable connection is OK	 <p>(solid)</p>	 <p>(solid)</p>

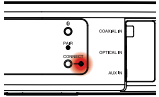

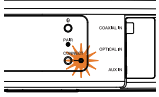

Device Operation	Description	Front LED Action	Rear LED Action
Setup	Connecting to your network	 (blink)	 (off)
	Configured and connected to your network	 (solid)	 (off)
	Error	 (solid)	 (solid)
Update	Updating	 (blink)	 (blink)

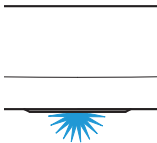
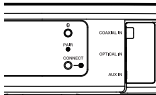
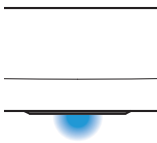
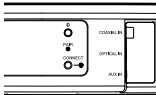
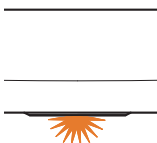
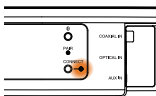
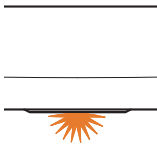
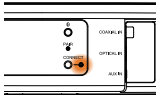

Device Operation	Description	Front LED Action	Rear LED Action
Update	Rebooting	 (blink)	 (off)
	Ready-Configured and connected to your network	 (solid)	 (off)
Reset	Soft reset - Clear user settings	 (fast blink)	 (solid)
	Hard reset - Factory restore	 (blink)	 (solid)

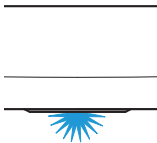
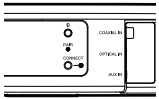

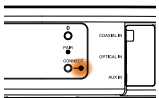
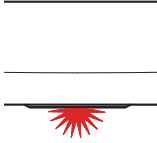
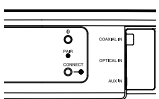
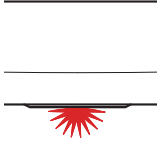
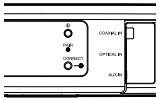

Device Operation	Description	Front LED Action	Rear LED Action
Reset	Rebooting	 <p>(blink)</p>	 <p>(off)</p>
	Ready-Not Configured	 <p>(solid)</p>	 <p>(solid)</p>
Errors	Firmware Error	 <p>(slow blink (NOT fade))</p>	 <p>(off)</p>
	Hardware Error	 <p>(fast blink)</p>	 <p>(off)</p>

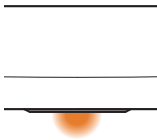
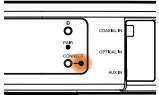
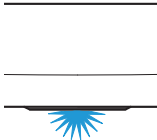
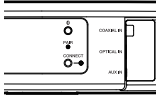
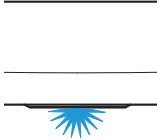
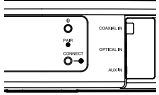
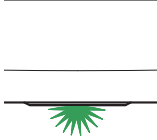
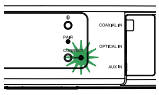

Device Operation	Description	Front LED Action	Rear LED Action
Errors	Network Error	 <p>(solid)</p>	 <p>(solid)</p>
Volume Change		 <p>(quick blink)</p>	 <p>(off)</p>
Mute		 <p>(slow blink)</p>	 <p>(off)</p>
WPS	a WPS session is active	 <p>(fast blink)</p>	 <p>(fast blink)</p>



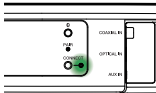
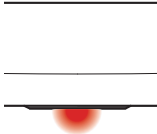
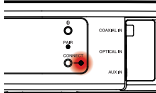
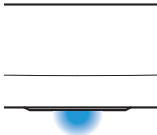
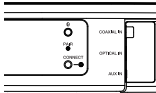

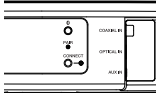

Device Operation	Description	Front LED Action	Rear LED Action
WPS	WPS connected	 (for 3 sec. solid)	 (solid)
	WPS time-out	 (for 3 sec. solid)	 (solid)
Power Management	Quick Start Mode	 (dimmed solid)	 (off)
	Deep Standby	 (off)	 (off)

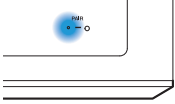

**Subwoofer**

Device Operation	Description	Rear LED Action
Subwoofer pairing	Paired	 <p>(solid)</p>
	Pairing	 <p>(blink)</p>
	Not paired	 <p>(solid)</p>



## Supported file types and codecs

Frequency	Sample Rate	File Extension	Codec	Bit Rates
32/44.1/48 88.2/96/176.4 192 kHz	16/24 bit	wav	PCM	---
32 kHz 44.1 kHz 48 kHz	16 bit	mp3	MPEG-1 Audio Layer 3 CBR/VBR	32 - 320 kbps
32 kHz 44.1 kHz 48 kHz	16 bit	m4a aac	AAC-LC	48 - 320 kbps
32 kHz 44.1 kHz 48 kHz	16 bit	wma	wma9 CBR	CBR:48 - 192 kbps
44.1/48 88.2/96/176.4 192 kHz	16/24 bit	flac	flac	---
44.1/48 88.2/96/176.4 192 kHz	16/24 bit	m4a	ALAC	---
2.8/5.6 MHz	1 bit	dff dsf	DSDIFF DSF	---

### NOTE

- Files protected by DRM such as Apple's Fairplay DRM, are not supported.
- The ALAC decoder is distributed under the Apache License, Version 2.0 (<http://www.apache.org/licenses/LICENSE-2.0>)

## Supported audio formats (Coaxial/Optical)

2-channel Linear PCM:2-channel, 32 kHz – 96 kHz, 16/20/24 bit

Bitstream:Dolby Digital, DTS



# Specifications

## Speaker specifications

### ■ Soundbar

#### Wireless LAN

Network type:	Conforming to IEEE 802.11a/b/g/n
Used frequency range:	2.4 GHz, 5 GHz

#### General

Wireless Technology:	5.8 GHz frequency hopping
Operating temperature:	41 °F - 95 °F (5 °C - 35 °C)
Power supply:	AC 100 – 240 V, 50/60 Hz
Power consumption in Quick Start Mode: *	4.5 W (Wi-Fi) 4.3 W (Ethernet) 4.4 W (USB) 4.2 W (Bluetooth) 4.1 W (HDMI IN) 4.5 W (HDMI OUT(ARC))
Power consumption in Deep Standby Mode: *	0.46 W
Max Analog Input:	2 Vrms

\*Cable to AUX IN must be disconnected to enter Quick Start Mode and Deep Standby Mode.



## Dimensions

Unit : in. (mm)

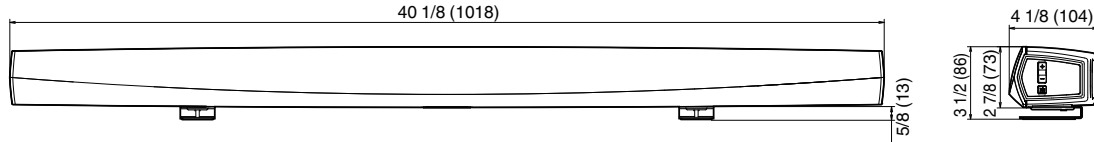

**Weight: 6 lbs 13 oz (3.1 Kg)**



## ■ Subwoofer

### General

Wireless Technology:	5.8 GHz frequency hopping
Operating temperature:	41 °F - 95 °F (5 °C - 35 °C)
Power supply:	AC 100 – 240 V, 50/60 Hz
Power consumption:	75 W
Power consumption in Quick Start Mode:	0.76 W

### Dimensions

Unit : in. (mm)

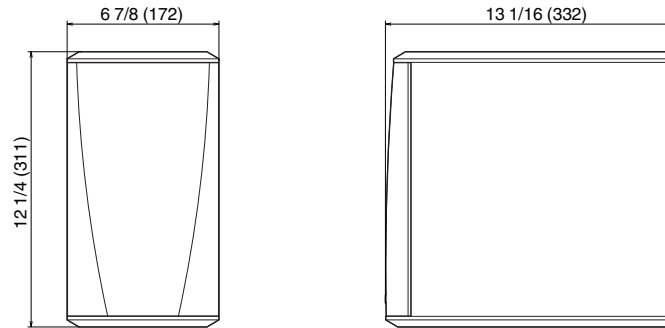

**Weight: 14 lbs 9 oz (6.6 kg)**

For the purpose of improvement, the specifications and design are subject to change without notice.



## Information

### Trademarks



Manufactured under license from Dolby Laboratories. Dolby, Dolby Audio, Pro Logic, and the double-D symbol are trademarks of Dolby Laboratories.



For DTS patents, see <http://patents.dts.com>. Manufactured under license from DTS, Inc. DTS, the Symbol, DTS and the Symbol together, and Digital Surround are registered trademarks and/or trademarks of DTS, Inc. in the United States and/or other countries. © DTS, Inc. All Rights Reserved.



The terms HDMI, HDMI High-Definition Multimedia Interface, and the HDMI Logo are trademarks or registered trademarks of HDMI Licensing Administrator, Inc.



Apple, the Apple logo, AirPlay, iPad Pro, iPad Air, iPad, iPhone, iPod touch and iPod are trademarks of Apple Inc., registered in the U.S. and other countries.

iPad mini are trademarks of Apple Inc.

The trademark "iPhone" is used in Japan with a license from Aiphone K.K.

IOS is a trademark or registered trademark of Cisco in the U.S. and other countries and is used under license.

Use of the Works with Apple badge means that an accessory has been designed to work specifically with the technology identified in the badge and has been certified by the developer to meet Apple performance standards.





Google Play and the Google Play logo are trademarks of Google LLC.



App Store is a trademark of Apple Inc., registered in the U.S. and other countries.



Amazon, Kindle, Echo, Alexa, Dash, Fire and all related logos are trademarks of Amazon.com, Inc. or its affiliates.



The Bluetooth® word mark and logos are registered trademarks owned by the Bluetooth SIG, Inc. and any use of such marks by D&M Holdings Inc. is under license. Other trademarks and trade names are those of their respective owners.





## License

### ■ License information for the software used in the unit

#### About GPL (GNU-General Public License), LGPL (GNU Lesser General Public License) License

This product uses GPL/LGPL software and software made by other companies.

After you purchase this product, you may procure, modify or distribute the source code of the GPL/LGPL software that is used in the product.

Denon provides the source code based on the GPL and LGPL licenses at the actual cost upon your request to our customer service center. However, note that we make no guarantees concerning the source code. Please also understand that we do not offer support for the contents of the source code.

This section describes software license used for this unit. To maintain the correct content, the original (English) is used.

### □ GPL

Open Source Used	Version
bridge-utils	2.8
busybox	1.21.1
ebtables	2.0.10-4
Linux kernel	3.10.74
mtd-utils	1.4.3
ntfs-3g_ntfsprogs	2011.4.12
ntpclient	2007
u-boot	2015.01
wireless-tools	version 29

### □ LGPL

Open Source Used	Version
ffmpeg	0.8.3
glibc	2.9
libmms	0.6.2

### □ curl-7.24.0

#### COPYRIGHT AND PERMISSION NOTICE

Copyright (c) 1996 - 2014, Daniel Stenberg, <[daniel@haxx.se](mailto:daniel@haxx.se)>

All rights reserved.

Permission to use, copy, modify, and distribute this software for any purpose with or without fee is hereby granted, provided that the above copyright notice and this permission notice appear in all copies.

THE SOFTWARE IS PROVIDED "AS IS", WITHOUT WARRANTY OF ANY KIND, EXPRESS OR IMPLIED, INCLUDING BUT NOT LIMITED TO THE WARRANTIES OF MERCHANTABILITY, FITNESS FOR A PARTICULAR PURPOSE AND NONINFRINGEMENT OF THIRD PARTY RIGHTS. IN NO EVENT SHALL THE AUTHORS OR COPYRIGHT HOLDERS BE LIABLE FOR ANY CLAIM, DAMAGES OR OTHER LIABILITY, WHETHER IN AN ACTION OF CONTRACT, TORT OR OTHERWISE, ARISING FROM, OUT OF OR IN CONNECTION WITH THE SOFTWARE OR THE USE OR OTHER DEALINGS IN THE SOFTWARE.

Except as contained in this notice, the name of a copyright holder shall not be used in advertising or otherwise to promote the sale, use or other dealings in this Software without prior written authorization of the copyright holder.



## ❑ e2fsprogs-libs-1.40.8/lib/uuid

Redistribution and use in source and binary forms, with or without modification, are permitted provided that the following conditions are met:

1. Redistributions of source code must retain the above copyright notice, and the entire permission notice in its entirety, including the disclaimer of warranties.
2. Redistributions in binary form must reproduce the above copyright notice, this list of conditions and the following disclaimer in the documentation and/or other materials provided with the distribution.
3. The name of the author may not be used to endorse or promote products derived from this software without specific prior written permission.

THIS SOFTWARE IS PROVIDED "AS IS" AND ANY EXPRESS OR IMPLIED WARRANTIES, INCLUDING, BUT NOT LIMITED TO, THE IMPLIED WARRANTIES OF MERCHANTABILITY AND FITNESS FOR A PARTICULAR PURPOSE, ALL OF WHICH ARE HEREBY DISCLAIMED. IN NO EVENT SHALL THE AUTHOR BE LIABLE FOR ANY DIRECT, INDIRECT, INCIDENTAL, SPECIAL, EXEMPLARY, OR CONSEQUENTIAL DAMAGES (INCLUDING, BUT NOT LIMITED TO, PROCUREMENT OF SUBSTITUTE GOODS OR SERVICES; LOSS OF USE, DATA, OR PROFITS; OR BUSINESS INTERRUPTION) HOWEVER CAUSED AND ON ANY THEORY OF LIABILITY, WHETHER IN CONTRACT, STRICT LIABILITY, OR TORT (INCLUDING NEGLIGENCE OR OTHERWISE) ARISING IN ANY WAY OUT OF THE USE OF THIS SOFTWARE, EVEN IF NOT ADVISED OF THE POSSIBILITY OF SUCH DAMAGE.

## ❑ expat-2.0.1

Copyright (c) 1998, 1999, 2000 Thai Open Source Software Center Ltd and Clark Cooper

Copyright (c) 2001, 2002, 2003, 2004, 2005, 2006 Expat maintainers.

Permission is hereby granted, free of charge, to any person obtaining a copy of this software and associated documentation files (the "Software"), to deal in the Software without restriction, including without limitation the rights to use, copy, modify, merge, publish, distribute, sublicense, and/or sell copies of the Software, and to permit persons to whom the Software is furnished to do so, subject to the following conditions:

The above copyright notice and this permission notice shall be included in all copies or substantial portions of the Software.

THE SOFTWARE IS PROVIDED "AS IS", WITHOUT WARRANTY OF ANY KIND, EXPRESS OR IMPLIED, INCLUDING BUT NOT LIMITED TO THE WARRANTIES OF MERCHANTABILITY, FITNESS FOR A PARTICULAR PURPOSE AND NONINFRINGEMENT.

IN NO EVENT SHALL THE AUTHORS OR COPYRIGHT HOLDERS BE LIABLE FOR ANY CLAIM, DAMAGES OR OTHER LIABILITY, WHETHER IN AN ACTION OF CONTRACT, TORT OR OTHERWISE, ARISING FROM, OUT OF OR IN CONNECTION WITH THE SOFTWARE OR THE USE OR OTHER DEALINGS IN THE SOFTWARE.



## ❑ getopt

<http://cvsweb.netbsd.org/bsdweb.cgi/src/lib/libc/stdlib/>

Copyright (c) 1987, 1993, 1994 The Regents of the University of California. All rights reserved.

Redistribution and use in source and binary forms, with or without modification, are permitted provided that the following conditions are met:

1. Redistributions of source code must retain the above copyright notice, this list of conditions and the following disclaimer.
2. Redistributions in binary form must reproduce the above copyright notice, this list of conditions and the following disclaimer in the documentation and/or other materials provided with the distribution.
3. Neither the name of the University nor the names of its contributors may be used to endorse or promote products derived from this software without specific prior written permission.

THIS SOFTWARE IS PROVIDED BY THE REGENTS AND CONTRIBUTORS "AS IS" AND ANY EXPRESS OR IMPLIED WARRANTIES, INCLUDING, BUT NOT LIMITED TO, THE IMPLIED WARRANTIES OF MERCHANTABILITY AND FITNESS FOR A PARTICULAR PURPOSE ARE DISCLAIMED. IN NO EVENT SHALL THE REGENTS OR CONTRIBUTORS BE LIABLE FOR ANY DIRECT, INDIRECT, INCIDENTAL, SPECIAL, EXEMPLARY, OR CONSEQUENTIAL DAMAGES (INCLUDING, BUT NOT LIMITED TO, PROCUREMENT OF SUBSTITUTE GOODS OR SERVICES; LOSS OF USE, DATA, OR PROFITS; OR BUSINESS INTERRUPTION) HOWEVER CAUSED AND ON ANY THEORY OF LIABILITY, WHETHER IN CONTRACT, STRICT LIABILITY, OR TORT (INCLUDING NEGLIGENCE OR OTHERWISE) ARISING IN ANY WAY OUT OF THE USE OF THIS SOFTWARE, EVEN IF ADVISED OF THE POSSIBILITY OF SUCH DAMAGE.

## ❑ jQuery

Copyright 2014 jQuery Foundation and other contributors

<http://jquery.com/>

Permission is hereby granted, free of charge, to any person obtaining a copy of this software and associated documentation files (the "Software"), to deal in the Software without restriction, including without limitation the rights to use, copy, modify, merge, publish, distribute, sublicense, and/or sell copies of the Software, and to permit persons to whom the Software is furnished to do so, subject to the following conditions:

The above copyright notice and this permission notice shall be included in all copies or substantial portions of the Software.

THE SOFTWARE IS PROVIDED "AS IS", WITHOUT WARRANTY OF ANY KIND, EXPRESS OR IMPLIED, INCLUDING BUT NOT LIMITED TO THE WARRANTIES OF MERCHANTABILITY, FITNESS FOR A PARTICULAR PURPOSE AND NONINFRINGEMENT. IN NO EVENT SHALL THE AUTHORS OR COPYRIGHT HOLDERS BE LIABLE FOR ANY CLAIM, DAMAGES OR OTHER LIABILITY, WHETHER IN AN ACTION OF CONTRACT, TORT OR OTHERWISE, ARISING FROM, OUT OF OR IN CONNECTION WITH THE SOFTWARE OR THE USE OR OTHER DEALINGS IN THE SOFTWARE.



## ❑ libpcap-1.4.0

License: BSD

Redistribution and use in source and binary forms, with or without modification, are permitted provided that the following conditions are met:

1. Redistributions of source code must retain the above copyright notice, this list of conditions and the following disclaimer.
2. Redistributions in binary form must reproduce the above copyright notice, this list of conditions and the following disclaimer in the documentation and/or other materials provided with the distribution.
3. The names of the authors may not be used to endorse or promote products derived from this software without specific prior written permission.

THIS SOFTWARE IS PROVIDED "AS IS" AND WITHOUT ANY EXPRESS OR IMPLIED WARRANTIES, INCLUDING, WITHOUT LIMITATION, THE IMPLIED WARRANTIES OF MERCHANTABILITY AND FITNESS FOR A PARTICULAR PURPOSE.

## ❑ libtar-1.2.11

Copyright (c) 1998-2003 University of Illinois Board of Trustees

Copyright (c) 1998-2003 Mark D. Roth

All rights reserved.

Developed by: Campus Information Technologies and Educational Services, University of Illinois at Urbana-Champaign

Permission is hereby granted, free of charge, to any person obtaining a copy of this software and associated documentation files (the "Software"), to deal with the Software without restriction, including without limitation the rights to use, copy, modify, merge, publish, distribute, sublicense, and/or sell copies of the Software, and to permit persons to whom the Software is furnished to do so, subject to the following conditions:

- \* Redistributions of source code must retain the above copyright notice, this list of conditions and the following disclaimers.
- \* Redistributions in binary form must reproduce the above copyright notice, this list of conditions and the following disclaimers in the documentation and/or other materials provided with the distribution.
- \* Neither the names of Campus Information Technologies and Educational Services, University of Illinois at Urbana-Champaign, nor the names of its contributors may be used to endorse or promote products derived from this Software without specific prior written permission.

THE SOFTWARE IS PROVIDED "AS IS", WITHOUT WARRANTY OF ANY KIND, EXPRESS OR IMPLIED, INCLUDING BUT NOT LIMITED TO THE WARRANTIES OF MERCHANTABILITY, FITNESS FOR A PARTICULAR PURPOSE AND NONINFRINGEMENT.

IN NO EVENT SHALL THE CONTRIBUTORS OR COPYRIGHT HOLDERS BE LIABLE FOR ANY CLAIM, DAMAGES OR OTHER LIABILITY, WHETHER IN AN ACTION OF CONTRACT, TORT OR OTHERWISE, ARISING FROM, OUT OF OR IN CONNECTION WITH THE SOFTWARE OR THE USE OR OTHER DEALINGS WITH THE SOFTWARE.



## ❑ mDNS 320.10.80

The majority of the source code in the mDNSResponder project is licensed under the terms of the Apache License, Version 2.0, available from:

<<http://www.apache.org/licenses/LICENSE-2.0>>

To accommodate license compatibility with the widest possible range of client code licenses, the shared library code, which is linked at runtime into the same address space as the client using it, is licensed under the terms of the "Three-Clause BSD License".

The Linux Name Service Switch code, contributed by National ICT Australia Ltd (NICTA) is licensed under the terms of the NICTA Public Software Licence (which is substantially similar to the "Three-Clause BSD License", with some additional language pertaining to Australian law).

## ❑ mongoose

<https://github.com/cesanta/mongoose/>

Copyright (c) 2004-2013 Sergey Lyubka

Permission is hereby granted, free of charge, to any person obtaining a copy of this software and associated documentation files (the "Software"), to deal in the Software without restriction, including without limitation the rights to use, copy, modify, merge, publish, distribute, sublicense, and/or sell copies of the Software, and to permit persons to whom the Software is furnished to do so, subject to the following conditions:

The above copyright notice and this permission notice shall be included in all copies or substantial portions of the Software.

THE SOFTWARE IS PROVIDED "AS IS", WITHOUT WARRANTY OF ANY KIND, EXPRESS OR IMPLIED, INCLUDING BUT NOT LIMITED TO THE WARRANTIES OF MERCHANTABILITY, FITNESS FOR A PARTICULAR PURPOSE AND NONINFRINGEMENT. IN NO EVENT SHALL THE AUTHORS OR COPYRIGHT HOLDERS BE LIABLE FOR ANY CLAIM, DAMAGES OR OTHER LIABILITY, WHETHER IN AN ACTION OF CONTRACT, TORT OR OTHERWISE, ARISING FROM, OUT OF OR IN CONNECTION WITH THE SOFTWARE OR THE USE OR OTHER DEALINGS IN THE SOFTWARE.



## ❑ openssl-1.0.0d

Copyright (c) 1998-2011 The OpenSSL Project. All rights reserved.

Redistribution and use in source and binary forms, with or without modification, are permitted provided that the following conditions are met:

1. Redistributions of source code must retain the above copyright notice, this list of conditions and the following disclaimer.
2. Redistributions in binary form must reproduce the above copyright notice, this list of conditions and the following disclaimer in the documentation and/or other materials provided with the distribution.
3. All advertising materials mentioning features or use of this software must display the following acknowledgment:  
"This product includes software developed by the OpenSSL Project for use in the OpenSSL Toolkit. (<http://www.openssl.org/>)"
4. The names "OpenSSL Toolkit" and "OpenSSL Project" must not be used to endorse or promote products derived from this software without prior written permission. For written permission, please contact [openssl-core@openssl.org](mailto:openssl-core@openssl.org).
5. Products derived from this software may not be called "OpenSSL" nor may "OpenSSL" appear in their names without prior written permission of the OpenSSL Project.
6. Redistributions of any form whatsoever must retain the following acknowledgment:  
"This product includes software developed by the OpenSSL Project for use in the OpenSSL Toolkit (<http://www.openssl.org/>)"

THIS SOFTWARE IS PROVIDED BY THE OpenSSL PROJECT "AS IS" AND ANY EXPRESSED OR IMPLIED WARRANTIES, INCLUDING, BUT NOT LIMITED TO, THE IMPLIED WARRANTIES OF MERCHANTABILITY AND FITNESS FOR A PARTICULAR PURPOSE ARE DISCLAIMED. IN NO EVENT SHALL THE OpenSSL PROJECT OR ITS CONTRIBUTORS BE LIABLE FOR ANY DIRECT, INDIRECT, INCIDENTAL, SPECIAL, EXEMPLARY, OR CONSEQUENTIAL DAMAGES (INCLUDING, BUT NOT LIMITED TO, PROCUREMENT OF SUBSTITUTE GOODS OR SERVICES; LOSS OF USE, DATA, OR PROFITS; OR BUSINESS INTERRUPTION) HOWEVER CAUSED AND ON ANY THEORY OF LIABILITY, WHETHER IN CONTRACT, STRICT LIABILITY, OR TORT (INCLUDING NEGLIGENCE OR OTHERWISE) ARISING IN ANY WAY OUT OF THE USE OF THIS SOFTWARE, EVEN IF ADVISED OF THE POSSIBILITY OF SUCH DAMAGE.

This product includes cryptographic software written by Eric Young ([eay@cryptsoft.com](mailto:eay@cryptsoft.com)). This product includes software written by Tim Hudson ([tjh@cryptsoft.com](mailto:tjh@cryptsoft.com)).



## ❑ portmap-6.0

Copyright (c) 1990 The Regents of the University of California.

\* All rights reserved.

\* Redistribution and use in source and binary forms, with or without modification, are permitted provided that the following conditions are met:

1. Redistributions of source code must retain the above copyright notice, this list of conditions and the following disclaimer.
2. Redistributions in binary form must reproduce the above copyright notice, this list of conditions and the following disclaimer in the documentation and/or other materials provided with the distribution.
3. A ll advertising materials mentioning features or use of this software must display the following acknowledgement:  
This product includes software developed by the University of California, Berkeley and its contributors.
4. Neither the name of the University nor the names of its contributors may be used to endorse or promote products derived from this software without specific prior written permission.

\* THIS SOFTWARE IS PROVIDED BY THE REGENTS AND CONTRIBUTORS "AS IS" AND ANY EXPRESS OR IMPLIED WARRANTIES, INCLUDING, BUT NOT LIMITED TO, THE IMPLIED WARRANTIES OF MERCHANTABILITY AND FITNESS FOR A PARTICULAR PURPOSE ARE DISCLAIMED. IN NO EVENT SHALL THE REGENTS OR CONTRIBUTORS BE LIABLE FOR ANY DIRECT, INDIRECT, INCIDENTAL, SPECIAL, EXEMPLARY, OR CONSEQUENTIAL DAMAGES (INCLUDING, BUT NOT LIMITED TO, PROCUREMENT OF SUBSTITUTE GOODS OR SERVICES; LOSS OF USE, DATA, OR PROFITS; OR BUSINESS INTERRUPTION) HOWEVER CAUSED AND ON ANY THEORY OF LIABILITY, WHETHER IN CONTRACT, STRICT LIABILITY, OR TORT (INCLUDING NEGLIGENCE OR OTHERWISE) ARISING IN ANY WAY OUT OF THE USE OF THIS SOFTWARE, EVEN IF ADVISED OF THE POSSIBILITY OF SUCH DAMAGE.

## ❑ pstdint.h-0.1.12

\* BSD License:

\* Copyright (c) 2005-2011 Paul Hsieh

\* All rights reserved.

\* Redistribution and use in source and binary forms, with or without modification, are permitted provided that the following conditions are met:

1. Redistributions of source code must retain the above copyright notice, this list of conditions and the following disclaimer.
2. Redistributions in binary form must reproduce the above copyright notice, this list of conditions and the following disclaimer in the documentation and/or other materials provided with the distribution.
3. The name of the author may not be used to endorse or promote products derived from this software without specific prior written permission.

\* THIS SOFTWARE IS PROVIDED BY THE AUTHOR "AS IS" AND ANY EXPRESS OR IMPLIED WARRANTIES, INCLUDING, BUT NOT LIMITED TO, THE IMPLIED WARRANTIES OF MERCHANTABILITY AND FITNESS FOR A PARTICULAR PURPOSE ARE DISCLAIMED.

\* IN NO EVENT SHALL THE AUTHOR BE LIABLE FOR ANY DIRECT, INDIRECT, INCIDENTAL, SPECIAL, EXEMPLARY, OR CONSEQUENTIAL DAMAGES (INCLUDING, BUT NOT LIMITED TO, PROCUREMENT OF SUBSTITUTE GOODS OR SERVICES; LOSS OF USE, DATA, OR PROFITS; OR BUSINESS INTERRUPTION) HOWEVER CAUSED AND ON ANY THEORY OF LIABILITY, WHETHER IN CONTRACT, STRICT LIABILITY, OR TORT (INCLUDING NEGLIGENCE OR OTHERWISE) ARISING IN ANY WAY OUT OF THE USE OF THIS SOFTWARE, EVEN IF ADVISED OF THE POSSIBILITY OF SUCH DAMAGE.



### ❑ **rl78flash 2000.3.1**

License

=====

The MIT License (MIT)

Copyright (c) 2012 Maxim Salov

Permission is hereby granted, free of charge, to any person obtaining a copy of this software and associated documentation files (the "Software"), to deal in the Software without restriction, including without limitation the rights to use, copy, modify, merge, publish, distribute, sublicense, and/or sell copies of the Software, and to permit persons to whom the Software is furnished to do so, subject to the following conditions:

The above copyright notice and this permission notice shall be included in all copies or substantial portions of the Software.

THE SOFTWARE IS PROVIDED "AS IS", WITHOUT WARRANTY OF ANY KIND, EXPRESS OR IMPLIED, INCLUDING BUT NOT LIMITED TO THE WARRANTIES OF MERCHANTABILITY, FITNESS FOR A PARTICULAR PURPOSE AND NONINFRINGEMENT. IN NO EVENT SHALL THE AUTHORS OR COPYRIGHT HOLDERS BE LIABLE FOR ANY CLAIM, DAMAGES OR OTHER LIABILITY, WHETHER IN AN ACTION OF CONTRACT, TORT OR OTHERWISE, ARISING FROM, OUT OF OR IN CONNECTION WITH THE SOFTWARE OR THE USE OR OTHER DEALINGS IN THE SOFTWARE.

### ❑ **sqlite 2003.5.7**

SQLite Copyright

SQLite is in the  
Public Domain

All of the code and documentation in SQLite has been dedicated to the public domain by the authors. All code authors, and representatives of the companies they work for, have signed affidavits dedicating their contributions to the public domain and originals of those signed affidavits are stored in a firesafe at the main offices of Hwaci. Anyone is free to copy, modify, publish, use, compile, sell, or distribute the original SQLite code, either in source code form or as a compiled binary, for any purpose, commercial or non-commercial, and by any means.

The previous paragraph applies to the deliverable code and documentation in SQLite - those parts of the SQLite library that you actually bundle and ship with a larger application. Some scripts used as part of the build process (for example the "configure" scripts generated by autoconf) might fall under other open-source licenses. Nothing from these build scripts ever reaches the final deliverable SQLite library, however, and so the licenses associated with those scripts should not be a factor in assessing your rights to copy and use the SQLite library.

All of the deliverable code in SQLite has been written from scratch. No code has been taken from other projects or from the open internet. Every line of code can be traced back to its original author, and all of those authors have public domain dedications on file. So the SQLite code base is clean and is uncontaminated with licensed code from other projects.





## ❑ **strncpy.c , v1.11**

- \* Copyright (c) 1998 Todd C. Miller <Todd.Miller@courtesan.com>
- \* Permission to use, copy, modify, and distribute this software for any purpose with or without fee is hereby granted, provided that the above copyright notice and this permission notice appear in all copies.
- \* THE SOFTWARE IS PROVIDED "AS IS" AND THE AUTHOR DISCLAIMS ALL WARRANTIES WITH REGARD TO THIS SOFTWARE INCLUDING ALL IMPLIED WARRANTIES OF MERCHANTABILITY AND FITNESS. IN NO EVENT SHALL THE AUTHOR BE LIABLE FOR ANY SPECIAL, DIRECT, INDIRECT, OR CONSEQUENTIAL DAMAGES OR ANY DAMAGES WHATSOEVER RESULTING FROM LOSS OF USE, DATA OR PROFITS, WHETHER IN AN ACTION OF CONTRACT, NEGLIGENCE OR OTHER TORTIOUS ACTION, ARISING OUT OF OR IN CONNECTION WITH THE USE OR PERFORMANCE OF THIS SOFTWARE.

## ❑ **taglib-1.5**

copyright : (C) 2002 - 2008 by Scott Wheeler  
email : [wheeler@kde.org](mailto:wheeler@kde.org)

"The contents of this file are subject to the Mozilla Public License Version 1.1 (the "License"); you may not use this file except in compliance with the License. You may obtain a copy of the License at <http://www.mozilla.org/MPL/>

Software distributed under the License is distributed on an "AS IS" basis, WITHOUT WARRANTY OF ANY KIND, either express or implied. See the License for the specific language governing rights and limitations under the License.

## ❑ **tinymce 2002.4.3**

[www.sourceforge.net/projects/tinymce](http://www.sourceforge.net/projects/tinymce)

Original file by Yves Berquin.

This software is provided 'as-is', without any express or implied warranty. In no event will the authors be held liable for any damages arising from the use of this software.

Permission is granted to anyone to use this software for any purpose, including commercial applications, and to alter it and redistribute it freely, subject to the following restrictions:

1. The origin of this software must not be misrepresented; you must not claim that you wrote the original software. If you use this software in a product, an acknowledgment in the product documentation would be appreciated but is not required.
2. Altered source versions must be plainly marked as such, and must not be misrepresented as being the original software.
3. This notice may not be removed or altered from any source distribution.



## ❑ Tremor

<http://wiki.xiph.org/index.php/Tremor>

Copyright (c) 2002, Xiph.org Foundation

Redistribution and use in source and binary forms, with or without modification, are permitted provided that the following conditions are met:

1. Redistributions of source code must retain the above copyright notice, this list of conditions and the following disclaimer.
2. Redistributions in binary form must reproduce the above copyright notice, this list of conditions and the following disclaimer in the documentation and/or other materials provided with the distribution.
3. Neither the name of the Xiph.org Foundation nor the names of its contributors may be used to endorse or promote products derived from this software without specific prior written permission.

THIS SOFTWARE IS PROVIDED BY THE COPYRIGHT HOLDERS AND CONTRIBUTORS "AS IS" AND ANY EXPRESS OR IMPLIED WARRANTIES, INCLUDING, BUT NOT LIMITED TO, THE IMPLIED WARRANTIES OF MERCHANTABILITY AND FITNESS FOR A PARTICULAR PURPOSE ARE DISCLAIMED. IN NO EVENT SHALL THE FOUNDATION OR CONTRIBUTORS BE LIABLE FOR ANY DIRECT, INDIRECT, INCIDENTAL, SPECIAL, EXEMPLARY, OR CONSEQUENTIAL DAMAGES (INCLUDING, BUT NOT LIMITED TO, PROCUREMENT OF SUBSTITUTE GOODS OR SERVICES; LOSS OF USE, DATA, OR PROFITS; OR BUSINESS INTERRUPTION) HOWEVER CAUSED AND ON ANY THEORY OF LIABILITY, WHETHER IN CONTRACT, STRICT LIABILITY, OR TORT (INCLUDING NEGLIGENCE OR OTHERWISE) ARISING IN ANY WAY OUT OF THE USE OF THIS SOFTWARE, EVEN IF ADVISED OF THE POSSIBILITY OF SUCH DAMAGE.

## ❑ zlib

<http://www.zlib.net/>

zlib.h -- interface of the 'zlib' general purpose compression library version 1.2.3, July 18th, 2005

Copyright (C) 1995-2004 Jean-loup Gailly and Mark Adler

This software is provided 'as-is', without any express or implied warranty. In no event will the authors be held liable for any damages arising from the use of this software.

Permission is granted to anyone to use this software for any purpose, including commercial applications, and to alter it and redistribute it freely, subject to the following restrictions:

1. The origin of this software must not be misrepresented; you must not claim that you wrote the original software. If you use this software in a product, an acknowledgment in the product documentation would be appreciated but is not required.
2. Altered source versions must be plainly marked as such, and must not be misrepresented as being the original software.
3. This notice may not be removed or altered from any source distribution.

Jean-loup Gailly [jloup@gzip.org](mailto:jloup@gzip.org), Mark Adler  
[madler@alumni.caltech.edu](mailto:madler@alumni.caltech.edu)



- ❑ **The Spotify software is subject to third party licenses found here:**

[www.spotify.com/connect/third-party-licenses](http://www.spotify.com/connect/third-party-licenses)



**DENON<sup>®</sup>**

[www.denon.com](http://www.denon.com)

3520 10712 00ADA

Copyright © 2019 D&M Holdings Inc. All Rights Reserved.