



ST-X DSP III SERIES
Owner's Manual

Before operating the unit, please read this manual thoroughly and retain it for future reference.

MISSION STATEMENT

Committed to Excellence

ZAPCO is dedicated to the pursuit of audio fidelity. Our prime objectives are to design and manufacture audio products of unsurpassed quality, to provide unparalleled support and service for these products and to conduct business in a manner that will enhance the quality of life for all involved.

Experience (Knowledge from doing)

There is absolutely no substitute for experience; that is a simple fact of life. Another simple fact is that ZAPCO has, for over forty years, been the leader in defining quality standards for the car audio industry.

These years of experience have led to a thorough understanding of the challenges that are unique to the world of car audio. ZAPCO's relentless quest for sonic purity consistently yields imaginative designs that utilize the most innovative technologies. The resulting products set the criteria by which all others in the industry are judged.

Table of Contents

A new level of Sound Quality	4
History of the Studio Series	4
The Studio-X DSP amplifiers	5
Main features of the Studio-X DSP amplifiers	5
Before you start your installation	6
Upgrading a Factory Stereo	6
Planning your power connections	7
Wire size	8
Mounting your Studio-X DSP amplifier	9
Inputs and Controls	10
ST-68X DSP III In/Out/Controls	10
ST-4X DSP III In/Out/Controls	12
ST-6X DSP III In/Out/Controls	13
The ST-X DSP GUI Program	14
Loading the GUI	14
Channel Setup	15
Delay	17
Ch. Selection and Crossover	19
Phase/Level	20
Equalizer	21
System Phasing	23
Tuning - The Simple Rules	25
Technical Specifications	27

Protect your audio investment by using the correct type of wire for Power and Ground.
See **All Wire is not created equal** on Page 6

A new level of Sound Quality

Zapco has a reputation for sound quality that is unsurpassed. It is our dedication to sonic purity and our passion for performance that built that reputation. With all the new amplifiers coming into the market, none has been any threat to Zapco's standing as the premiere amp and processor company for pure sound quality.

Just check out the audio competition scene. The pros know what to use to win. Competition amps however, do not come cheap, and not everyone wants to compete. The challenge then, was to put Zapco's 40 plus years of experience to use in the development of an amplifier that would bring Zapco sound a line of products for every-day use and that everyone could afford. And the studio line is just that amplifier. In the time it has been out it has built a reputation as the best sounding amp in the class.

Of course, not everyone buys strictly by sound (although they should). Maybe it's the wrong color, maybe it's too big... or too small. But one thing is constant. Everyone who hears the studio amps agrees; it sounds better than any other product in the class.

History of the Studio Series

Perfection cannot be achieved. But that does not make its pursuit less valuable. Zapco is committed to making every product we make better than the last. We introduced the ST-X amps in 2013. In 2015 we improved the PCB design and upgraded components to make the sonically improved ST-X II.

Three years ago we introduced the Studio-X SQ amplifier to take affordable sound quality to a new level. We added the proprietary RCA connectors from the Z-LX amplifiers, changed the capacitors to a higher end audio cap, and made a few other small changes. All this takes took the Studio sound to a new level of sonic performance for an affordable amplifier.

For 2019, we brought digital processing to the studio line in DSP/AMPs that can be controlled by PC or by iOS or Android mobile apps. For 2021 we have upgraded the ST-DSP with new features and functions to improve your listening experience. And developed a new aluminum heat sink for improved efficiency and reliability under extreme temperature and hard play.

The Studio-X DSP III Amplifiers

With the new Studio-X DSP amps you get the sound quality that other companies offer only in their big competition amps (and better than many of them) in a compact chassis with 25W RMS/Channel @ 4Ω (ST-68X DSP III), 65W RMS/Channel @ 4Ω (ST-4X DSP III), 100W/Ch. @ 4Ω (ST-6X DSP III) plus the tuning power of the ST Digital Processing System. The on-board DSP provides a wide variety of digital Crossovers, Parametric EQ as well as Signal Delay, Polarity, and gain for each channel. As for analog performance, the Studio X DSP amps give you more than power. These amps have 0.2% THD+noise, over 90dB signal to noise, over 60dB separation, and produce power from 15 Hz to 30 KHz.

Main features of the Studio-X DSP III amplifiers

- 4-Ch or 6-Ch Full Range, Class A/B Amplifier
- On-Board, Full Function, 8-Ch Digital Signal Processing
- HP/LP filters, Signal Delay, Phase (Polarity) control
- 15 Channels of Parametric Equalization on each channel
- Optional BT Streaming (Bluetooth Port for external BT Module)
- High-level Speaker Input
- And of course, Zapco sound quality
- Analog input level controls with 2-stage clip indicators for accurate, distortion free gain settings
- Toslink Optical input for the ST-4X and ST-6X models
- New high efficiency finned heat sink

Before you start your installation

ZAPCO highly recommends that a fuse or circuit breaker be placed within 18" of the battery. Although you will add a fuse or fuse block near the amplifier it is still a possibility that a pinched power wire between the component fuse and the battery could result in a short, or even a fire. The protection device should be placed where it can be accessed easily and all wiring should be routed safely and correctly according to the following guidelines:

- Do not run wiring close to hot or spinning objects.
- Always use wire grommets when routing wire through the firewall or any other metal panels.
- Make sure that the potential for pinched wiring is avoided by routing all wires away from moving objects, including brake, gas and clutch pedals, etc.

When connecting our amplifiers to pre-wired stock speakers, care must be taken that there are no common connections between left and right speaker wires, i.e. two or more speakers using the same ground connection (very common in pre-85 cars), as this will cause the amplifier to go into immediate protection or may cause damage to the amplifier. Output connections are not common chassis ground. Please follow the hookup instructions in this owner's manual. Any questions should be directed to your local ZAPCO dealer.

Upgrading a Factory Stereo

If you are upgrading a factory stereo, the ST-X DSP amps have a separate speaker level input plug that senses current, so you do not need to run a turn-on wire. However, auto-on is not useful in all cars as the amplifier can come on in some cars even when the stereo is not on, because of the car's electrical system. The ST-X DSP amps have a switch that allows you to defeat the auto-on if you find you do not want to use that function.

All Wire is not created equal

Please do not use CCA wire with Zapco amplifiers

It is easy to think of wire as just wire but the fact is there are major differences between the types of wires being offered today. The price of copper has gone up quite a bit lately, but you will notice that you can still buy heavy primary wire at very reasonable prices. How can this be? Simple... That lower price wire is not all copper, it is CCA wire. CCA stands for Copper Clad, Aluminum. That means it is aluminum wire with a thin coating of copper around the outside of the wire. Does it look like copper wire? Absolutely. But does it conduct electrical current like copper? Absolutely NOT!

If the wire does not say OFC Copper wire or Solid Copper wire do not use it.

Two things can and likely will happen:

- Because CCA wire can not conduct DC electrical current like copper wire can, your amp will not get the current it needs to produce its rated power. That means you get less power and more distortion. It also taxes the amplifier that is trying to make its power, shortening the life of the amp.
- CCA wire corrodes quickly and causes terminals that used to be tight to become loose. This causes arcing when electrons to fly around all the open space lookin for more copper. This causes heat that damages connections and can even eventually melt the terminal blocks on your amplifier.

In short: While CCA wire is excellent for high frequency AC current (like tweeter voice coils), it is absolutely bad for high current 12V DC like power and ground for a car audio amplifier.

We have seen CCA wire become a major cause of amplifier failures as buyers are offered CCA as a low cost alternative to pure copper wire. So always look at the description of the contents of wire that you purchase. When someone offers to save you some money with CCA wire just say "No, thank you". Protect your investment with real copper wire.

Planning your power connections

The power end plates of the Zapco ST-X III amplifiers carry the power connections and the speaker connections and vary somewhat by the number of channels. The main 12-volt power input, the 12-volt turn-on wire, and the main Ground connection are common to both models.

- The main power must be connected the vehicle battery's positive (+) terminal, and a main system fuse should be placed close to the battery
- The main ground or negative must be securely attached to bare metal at the vehicle frame, or other chassis component with a direct connection to the frame

Note: Seat bolts and seat belt bolts are NOT good ground points

- The REM terminal can be connected to the head unit turn-on output wire. If none is available it can be connected to an accessory (ACC) terminal. You should avoid using any ignition-on (IGN) wire, as they can be noisy

Some words about Power and Ground

The second most common cause of under performing amplifiers is insufficient power current or a poor power connection. The most common cause of under performing amplifiers is insufficient ground current or a bad ground connection.

12-volt current: Battery power works only if it travels in a complete circuit from the battery positive terminal to the battery negative terminal. Main power input, of course, is attached to the battery positive terminal. Ground current is returned to the battery through the chassis to the point where the battery is grounded.

The current available for your amplifier to use to produce power will be restricted by the smallest gauge of wire in the circuit and by the weakest physical connection in the circuit.

Wire Size

It's often surprising how many people will obsess about signal wire but routinely provide the amplifier with only a fraction of the current it needs to do its job. The most common wire gauge used in car audio is 10-gauge, and the most common location for amplifiers is in the trunk.

Wire Sizing Chart

	←----- Length of Run -----→							
	4 ft	7 ft	10 ft	13 ft	16 ft	19 ft	22 ft	28 ft
0-20 amps	14	12	12	10	10	8	8	8
20-35 amps	12	10	8	8	6	6	6	4
35-50 amps	10	8	8	6	6	4	4	4
50-60 amps	8	8	6	4	4	4	4	2
65-85 amps	6	6	4	4	2	2	2	0
85 -105amps	6	6	4	2	2	2	2	0
105-125 amps	4	4	4	2	2	0	0	0
125-150 amps	2	2	2	2	0	0	0	0

Let's look at a fairly small system. If you use a 50 watt/ch amp (25 amps) for the highs and a 100 watt/ch amp (40 amps) for the woofers, you need at least a 4-gauge and maybe a 2-Gauge wire to provide 65 amps at the trunk. Use the Wire Sizing Chart. Add up the fuse values on the amplifier(s) then choose the proper size wire based on the distance from the car battery to the amplifier location. Always use the same gauge wire for the main ground as you do for the main power. Always make your ground as short as possible and secure it to a clean solid surface, preferably the vehicle frame.

Mounting your ST-X DSP III amplifier

Mounting your Zapco amplifier is easy. Just keep in mind a few guidelines:

- The amplifier can be mounted in any direction, on wood, metal, or carpet
- The metal chassis of the amp can be grounded or left isolated
- The amplifier requires adequate ventilation. Creating power creates heat, and cooling requires air. Position the amplifier with sufficient surrounding area for air supply and keep the end plates clear for future access
- Keep the amplifier out of the engine compartment or other locations that may cause excessive heat or moisture
- Do not mount the amplifier to a subwoofer box or other place that may have excessive vibration

Setting Gains: Gain pots are not volume controls. Before you first turn on your system, you should make sure all gain controls are set to minimum. Gain controls should be used only if absolutely necessary. Turning up gain controls causes increased noise, makes distortion more likely and reduces the dynamic range of your system. If your head unit does not have sufficient output, you will get much better results by investing in a line driver to provide more signal to the amplifier.

ST-68X DSP III Input/Controls

The ST-68X DSP III is a 4-Channel amplifier with on-board Digital processing. The input functions are described below.

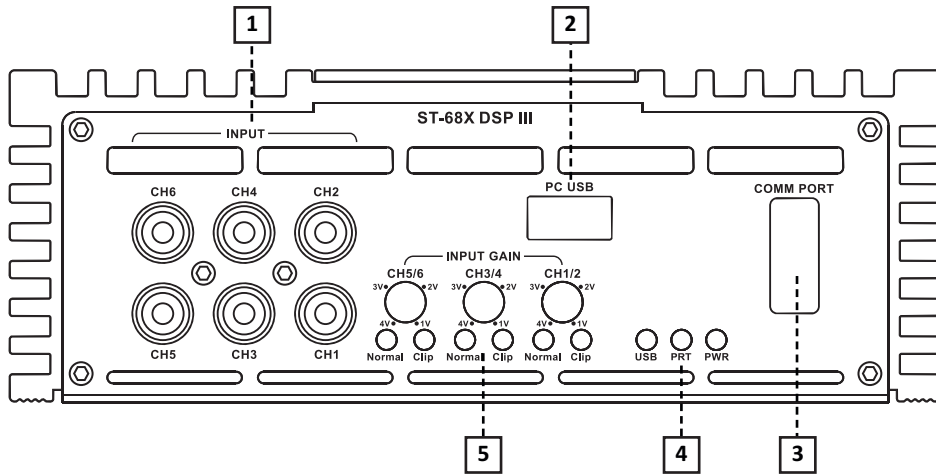

- 1• 6 Channels of RCA level inputs for the internal amplifier
- 2• USB Port for PC control connection
- 3• Comm Port for BT modules
- 4• USB, Protection, Power Led
- 5• Analog input level (gain) controls with 2-stage clipping indicators

ST-68X DSP III Output/Speakers

The other side of the ST-68X DSP III with the output functions, Auto turn-on, and the speaker/power connector.

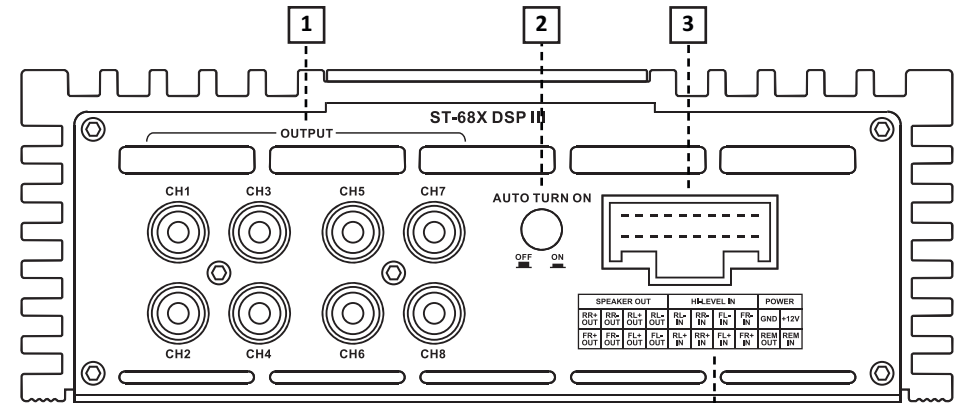

- 1• 8 Channels of processed RCA outputs for external amplifiers
- 2• Auto turn-on selector
- 3• OEM Connector for speaker In/Out and Power

SPEAKER OUT				HI-LEVEL IN				POWER	
RR+ OUT	RR- OUT	RL+ OUT	RL- OUT	RL- IN	RR- IN	FL- IN	FR- IN	GND	+12V
FR+ OUT	FR- OUT	FL+ OUT	FL- OUT	RL+ IN	RR+ IN	FL+ IN	FR+ IN	REM OUT	REM IN

ST-4X DSP III Input/Controls/Output/Speakers

The ST-4X DSP is a 4-Channel amplifier with on-board Digital processing. The input functions are described below.

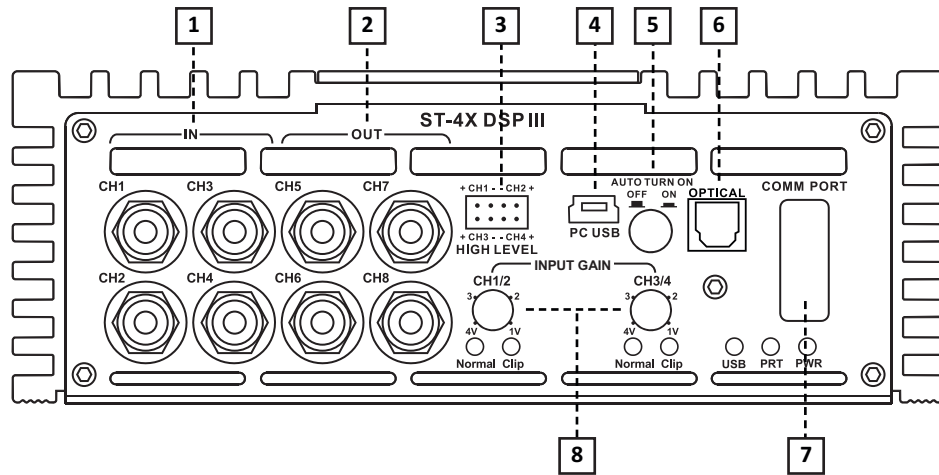

- 1• 4 Channels (1/2 and 3/4) of RCA level inputs for the internal amplifier
- 2• 4 Channels (5/6 and 7/8) of processed RCA outputs for external amplifiers
- 3• 4 Channels High-level OEM input plug
- 4• USB Port for PC control connection
- 5• Auto turn-on switch to turn the system on by signal sensing
- 6• The Toslink connector provides an SPDIF digital input
- 7• Comm Port for BT modules
- 8• Analog input level (gain) controls with 2-stage clipping indicators
- 9• Power (Ground, Rem, +12V Battery) 10• Fuses 11• Speaker terminals

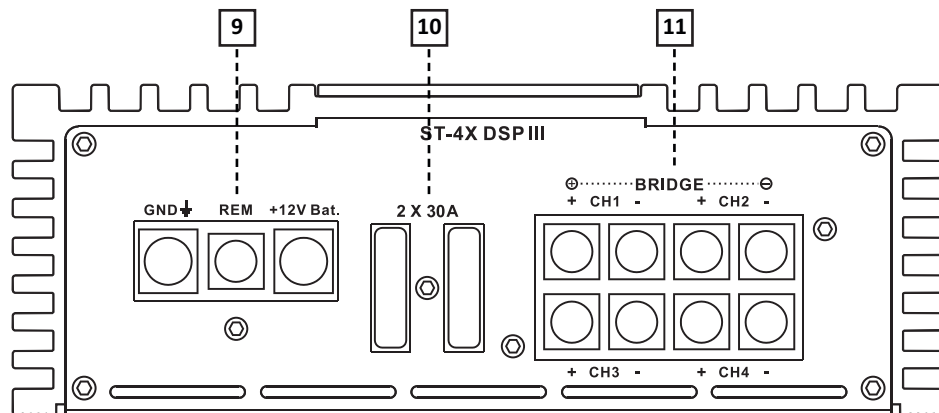

ST-6X DSP III Input/Controls/Output/Speakers

The ST-6X DSP is a 6-Channel amplifier with on-board Digital processing. The input functions are described below.

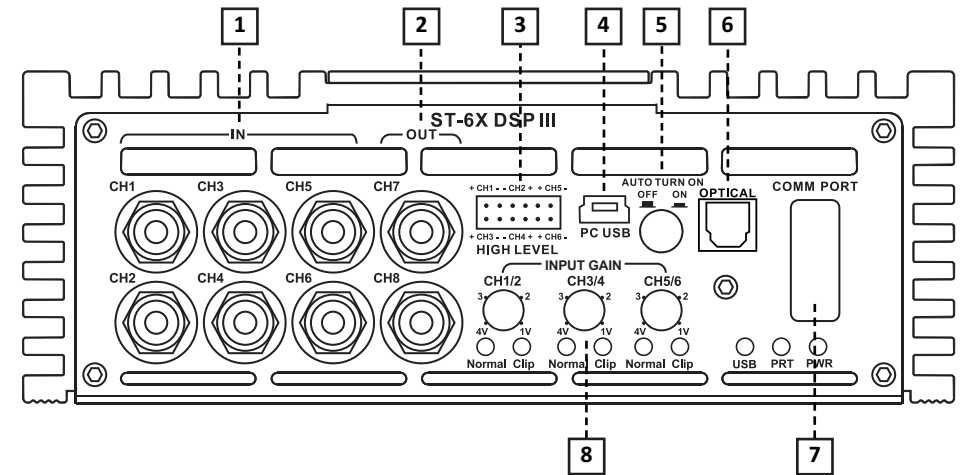

- 1• 6 Channels (1/2, 3/4, 5/6) of RCA level inputs for the internal amplifier
- 2• 2 Channels (7/8) of processed RCA outputs for external amplifiers
- 3• 6 Channels High-level OEM input plug
- 4• USB port for PC control connection
- 5• Auto turn-on switch to turn the system on by signal sensing
- 6• The Toslink connector provides an SPDIF digital input
- 7• Comm Port BT modules
- 8• Analog input level (gain) controls with 2-stage clipping indicators
- 9• Power (Ground, Rem, +12V Battery) 10• Speaker terminals

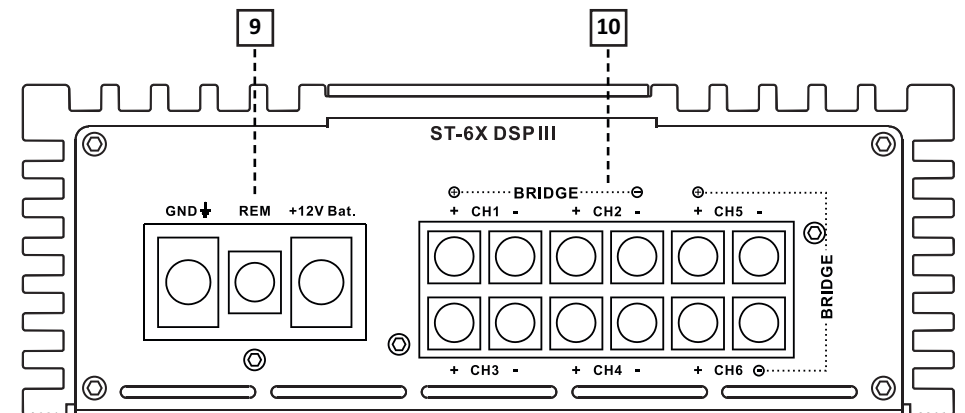

The ST-X DSP GUI Program

Before beginning the setup be sure all signal sources are turned fully down so there is no volume until after the crossovers are set.

The control program (GUI) for the ST-X DSP amplifiers is the same functionally for all the models except for the number of channels. Both will have a default system in the channel designation column but since you have complete control over all functions, you can use all channels as they best suit your individual system.



Loading the GUI

Download the GUI (Graphic User Interface) from www.zapco.com > Downloads, if you have not already done that, and load the GUI from the .exe file.

Connecting the PC: Connect the PC to the ST-X DSP amp using the supplied USB cable.

NOTE: The ST-X DSP GUI is very forgiving about PC Screen resolution. However the ideal resolution 1600 x 900 optimal on most PC's.

Working with the GUI

Navigation bar: At the very top of the Screen you will find the Navigation bar.

At the left is the connection indicator. When you open the program while you are connected to the DSP it will automatically link so you can use the GUI.

If connection is lost it will show Not Linked so you can check the connections.

Next is **Channel Setup**, which is where you will tell the program what inputs and outputs you are using.



To begin you need to define your system. Fixed 2-Ch inputs (Toslink and Digital BT) will apply left channel information to all odd number output channels and right channel information to all even numbered output channels. The analog input is for Aftermarket head units and OEM (factory) head unit adaptations. These can be 2-Ch, 4-Ch, or 6-Ch RCA inputs. There are also 4-Ch of speaker level inputs for OEM Integration. The SUM button will combine highs and lows from a 2-way factory system to make a single full range signal for processing. The Custom/Sum lets you determine your configuration. After you have chosen your input you can move on using the GUI.

Save, lets you save to a file on the PC or to a preset in the Processor. After you spend valuable time setting up and tuning the system, you won't want to lose the setup, so you always want save your setup to one of the available presets. And for a backup and to keep extra presets you should save all your setup and tunes to a file on your PC.

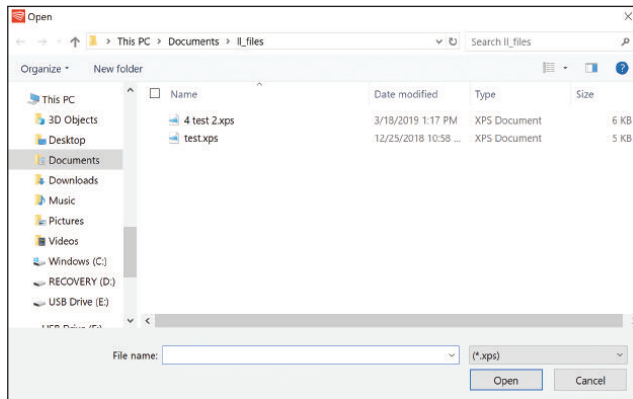
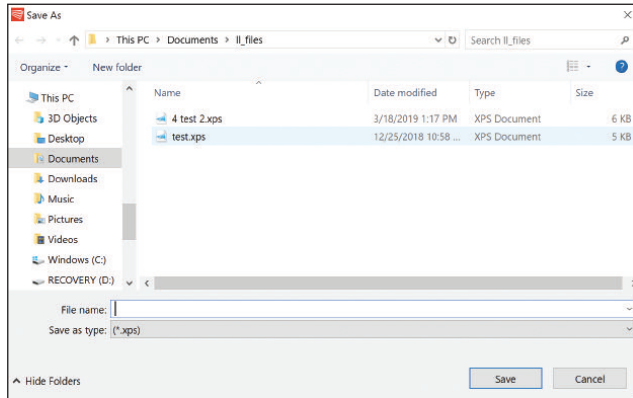

When you Save to File you will be taken to a folder on the PC so you can choose a name for the tune and click Save.

Load, of course, works just the opposite. Click load from file and you will go to the same folder, pick the desired preset, and click Open.

At the right side of the Navigation bar is the setting button. This will only be used if there is a firmware upgrade at some future point in time.

The Main GUI Screen

The main screen has upper and lower sections. The upper section is where all the original system setup will take place, while the lower section contains the equalization controls and the frequency graph.

Delay: At the left of the main GUI Screen is the Delay section. Since you can not sit directly in the center of the car, the program can delay the arrival time of near speakers so it will sound as though you are right in the middle of the car. Setting delay is quite straightforward. The purpose is to make every speaker the same distance from you, so you are in the middle.

- Measure the distance between each speaker and where your ears will be in the actual listening position.
- Identify the farthest speaker.
- Add distance to each of the other speaker so that ALL speakers have the same distance. You do this by subtracting each of the shorter speaker distances from the longest (see example below).

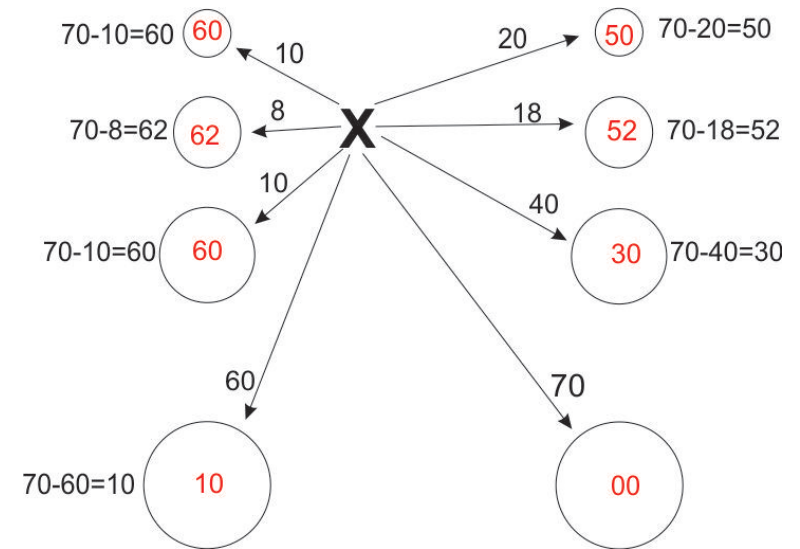

In this example, the longer speaker distance is 70" so we subtract each of the other speakers from 70 and enter the results in the Delay chart. After you have entered the distances in **cm** or **inch** you can click **ms** to see the delay in milliseconds.



The next section holds the **Channel Selection** and **Crossover**.

DSP CHANNEL	LINK	HIGH PASS			LOW PASS		
		FREQ	TYPE	SLOPE	FREQ	TYPE	SLOPE
CH-1 FL TW	<input type="checkbox"/>	4000	LINK-R ▾	24dB/O ▾	20000	LINK-R ▾	24dB/O ▾
CH-2 FR TW	<input type="checkbox"/>	4000	LINK-R ▾	24dB/O ▾	20000	LINK-R ▾	24dB/O ▾
CH-3 FL WF	<input type="checkbox"/>	80	LINK-R ▾	24dB/O ▾	4000	LINK-R ▾	24dB/O ▾
CH-4 FR WF	<input type="checkbox"/>	80	LINK-R ▾	24dB/O ▾	4000	LINK-R ▾	24dB/O ▾
CH-5 RL	<input checked="" type="checkbox"/>	80	LINK-R ▾	24dB/O ▾	20000	LINK-R ▾	24dB/O ▾
CH-6 RR	<input type="checkbox"/>	80	LINK-R ▾	24dB/O ▾	20000	LINK-R ▾	24dB/O ▾
CH-7 L-OUT	<input type="checkbox"/>	20	LINK-R ▾	24dB/O ▾	80	LINK-R ▾	24dB/O ▾
CH-8 R-OUT	<input type="checkbox"/>	20	LINK-R ▾	24dB/O ▾	80	LINK-R ▾	24dB/O ▾

You can select a channel to tune by clicking on the desired speaker in the car diagram/Delay section or by clicking on its box in the DSP Channel column. You can pick channels on at a time or you can pick them by pair. Double clicking the dot between a pair of channels links that pair. Similarly, if one channel is already chosen and active, then clicking on the dot will pair them.

This is important as you should always set crossovers by channel pair so the left and right speakers will be the same. It is also easiest to do initial equalization by channel pair.

Each channel has a High Pass and a Low Pass filter. You can control the frequencies of the filters by highlighting the FREQ box and typing in a value or by using the keyboard up/down arrows. You can choose the Shape of the crossover from Butterworth, Linkwitz-Riley, or Bessel and the Slope using the drop-down menus. The default crossovers are all 24dB/Octave Linkwitz-Riley.

The best source for information on the proper crossovers for your own speakers is the speaker maker. He can tell you what crossover to use and also how much power the speakers can handle at different slopes and frequencies.

Phase/Level: The next section is for adjusting levels and checking Polarity to be sure all speakers are in phase with each other.



There are a number of systems for checking System Phase. If the systems speakers are not all in phase there will be issues you can not fix by tuning. You can see the section on System Phasing to see one method of Phase checking. The MUTE buttons allow you to turn off any speakers that you do not want to hear while you are tuning other speakers. You will also find a master level control here and a system MUTE button.

Equalizer: The lower section of the GUI is devoted to equalization.

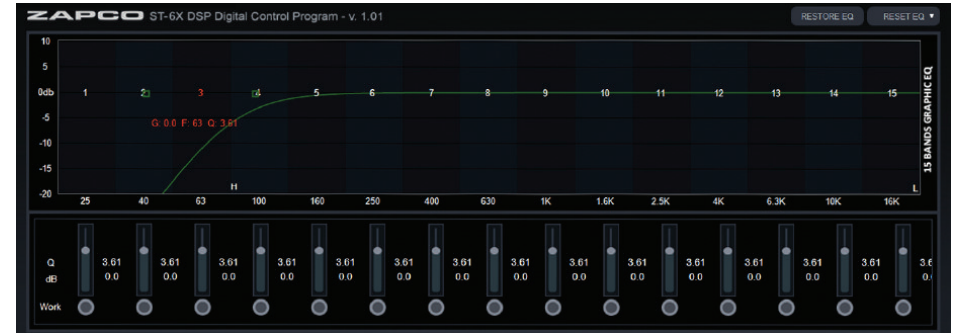

Here are 15 bands of parametric equalization for each output channel and you can vary Frequency, Gain, and Q (the shape of the adjustment) for each band in several ways. Frequency: Each band is numbered. You can simply click onto a band button and drag it to where you want it. When you click onto a band there is a "Heads-up display" of the frequency, gain, and Q of the band. Any band that has been adjusted from 0dB is highlighted by the green dot under the band's slider.

Band # shows in Red, as do the Gain, Freq, and Q. The green squares show the width (Q) of the filter.

You can click into the Gain or Q value box of any band and adjust using the up/down arrow keys.

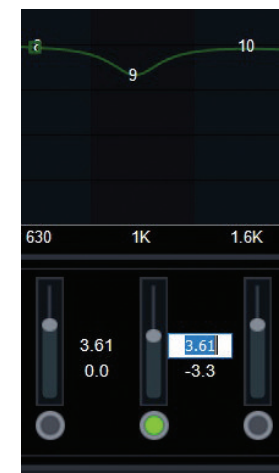

Gain: Gain can be adjusted by using the up/down arrows when the band's EQ dot is highlighted. You can also click into the gain or Q rows of any band and adjust with the up/down arrows. You can move from one band to the next with the right/left keyboard arrows.

Q Setting: Q can be set as above using the keyboard arrows. You can also make rough adjustments by dragging one of the green boxes in the EQ graph to make Q wider or narrower to affect a smaller or larger group of frequencies with your EQ adjustment.



To aid the tuning process you can temporarily bypass a channels equalization. You can also the reset function to reset one channel or to reset all channel to default positions with no equalization.

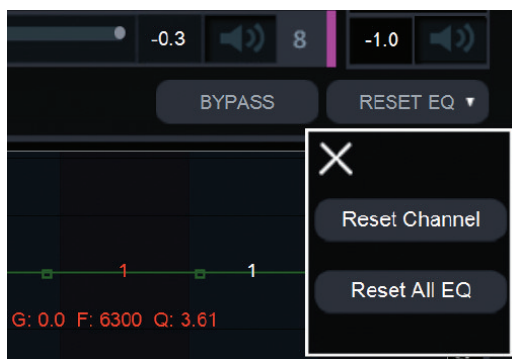

System Phasing: Before you start the equalization you want to be sure the system is phased properly. Below we offer one system to help you phase the system.

You were promised more on polarity. Before equalization you should assure that all speakers are in phase as a system at the listening position. All speakers need to have the same polarity so they move the same direction at the same time. If they are not, you will not be able to get a proper tune. There are a number of methods for doing this. We offer one.

Tweeters: (A) Mute all speakers except the tweeters and play a high female vocal soloist. You should hear the voice at a single point near upper middle of the windshield. If the speakers are out of phase the voice will not be localized but will seem to come from everywhere. To test, using the Phase buttons, change the phase of the right speaker and listen for the difference. Do this a couple of times as needed. The position that puts the voice in a small single

location on the window is the correct phase. (B) Note where the Tweeter center is located. It should be just slightly above and to the left of the center of the windshield (for left hand drive cars). If it is off to the opposite side of center or too far to the left, and if you have measured correctly, then you have a gain difference and you can correct by a slight level adjustment reduce the right tweeter to bring it left or reduce the left channel to take it right. No more that 1dB or 2dB. Now the tweeters are set. From here on out you cannot change the levels or phase of either tweeter.

Mids, Mid-bass (woofers), and subs: Now mute the tweeters and un-mute the midranges. The process is the same for each pair of speakers. The sound should come from a single focused point near the center of the windshield. For midranges and larger drivers, you want to use a deeper male vocal. The larger drivers are much easier to tell the differences between in-phase and out of phase. Also, with the larger speakers you will hear a dramatic reduction of bass if the speakers are out of phase. So, for midrange and larger speakers you will look for a focused sound source in the windshield with stronger bass.

NOTE: Once each channel pair is adjusted, they cannot be separated. Any change of phase must be done by the pair.

Phasing the pairs: Again, listening to a single vocalist. Mute all channels again except the tweeters. Then bring in the midranges. If these pairs are in proper phase the sound should be near center in the upper part of the windshield. If they are not in phase the sound will be pulled down lower. You can reverse the phase of BOTH mids now and listen for the difference in the sound location. Choose the phase position that puts the sound high near the center.

Once you have these phased you can bring in the mid-bass with the same process. Again, the focus should be high in the dash. If the mid-bass is out of phase with the tweeters and mids then they will pull the sound down toward the floor.

Woofers or Subs: There will be bass! You have phased the woofers, so we know there will be bass. What you need to listen for here is location, and mid-bass (something with kick drums is ideal). Proper woofer phasing will work with the mid-bass drivers to give good solid, crisp mid-bass. Out of phase will result in a soft, low-impact mid-bass. Bass out of phase with the mid-bass will also be more located in the back of the vehicle while a properly phased bass will blend better into the front soundstage.

Tuning - The Simple Rules

Before you can get what, you want you need to know what you want. In the graphs below, we look at some different response curves and what they mean and sound like.

Keep in mind that these illustrations are NOT what your EQ graph looks like. They are what your RTA looks like. If you have a flat response like below on your RTA, your EQ graph will have lots high spots and low spots to make the RTA graph look like that.

Flat is not the goal: Generally, a flat response will give a sound lacking in bass and will sound harsh on the high end and a little "thin" without a lot of body.

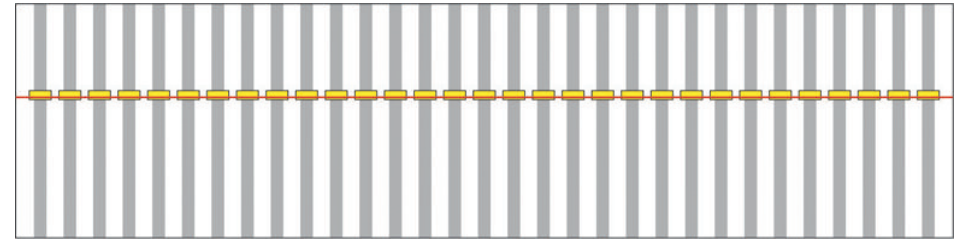

An Excellent response curve: Here is a curve that will almost always sound superb in a vehicle. The bass area as 3 to 4dB above the midrange and the highs slope off smoothly. This will have good solid bass and a smooth sound through the midrange and highs.

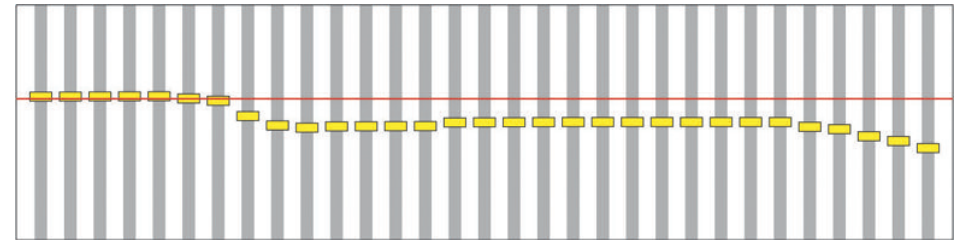

Problem Curve: Here is a problem curve. The small variations in blue are OK. They are 2dB or less and you likely will never hear them. However, the variations in the red circles are bad. While the ear is not so sensitive to dips in the response, it is very sensitive to peaks. The response peaks are what makes a speaker sound "harsh" and cause "ear fatigue" (You listen for a while then turn it off because it starts to irritate your ears). With this curve you want to pull down those peaks to put them in line with the rest of the signal response. Once that is done the system should sound just about right.

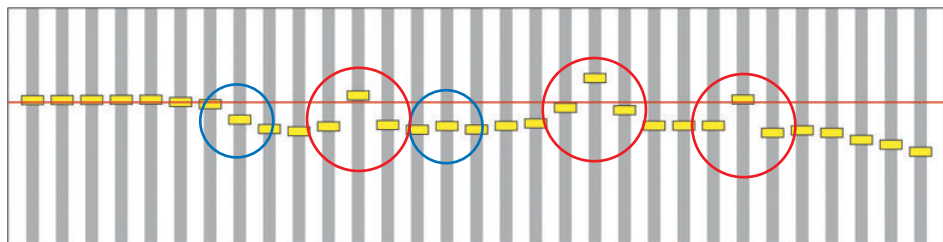

Technical Specifications

	ST-68X DSP III	ST-4X DSP III	ST-6X DSP III
Power @ 4Ω:	4 x 25 watts	4 x 65 watts	6 x 100 watts
THD @ Rated Power:	< 0.5%	< 0.5%	< 0.5%
Power @ 2Ω:	4 x 35 watts	4 x 90 watts	6 x 130 watts
Power Bridged @ 4Ω:	-	2 x 180 watts	3 x 250 watts
S/N Ratio:	> 90dB	> 90dB	> 90dB
THD + Noise:	< 0.2%	< 0.2%	< 0.2%
Channel Separation:	> 60dB	> 60dB	> 60dB
RCA:	6 In. / 8 Out	4 In. / 4 Out	6 In. / 2 Out
Input Sens. Low:	1V/4V	1V/4V	1V/4V
Input Sens. High:	4V/8V	4V/8V	4V/8V
Digital Input:	-	Toslink Optical	Toslink Optical
Comm Port:	BT Mod. (opt.)	BT Mod. (opt.)	BT Mod. (opt.)
Auto Turn-On:	Yes	Yes	Yes
Status Led:	Clip/USB/Prt/Pwr	Clip/USB/Prt/Pwr	Clip/USB/Prt/Pwr
Freq. Response ±1dB:	15Hz - 30KHz	15Hz - 30KHz	15Hz - 30KHz
Equalizer:	Parametric, 15-bands	Parametric, 15-bands	Parametric, 15-bands
Delay:	cm/inches/ms	cm/inches/ms	cm/inches/ms
Mute:	Yes, each channel	Yes, each channel	Yes, each channel
Crossover Type:	Butt./ Linkw./Bessel	Butt./ Linkw./Bessel	Butt./ Linkw./Bessel
Dim. (WxHxL):	160 x 57 x 131 mm	160 x 57 x 284 mm	160 x 57 x 450 mm
Overall (WxHxL):	160 x 57 x 156 mm	160 x 57 x 309 mm	160 x 57 x 475 mm

Continuous exposure to excessive sound pressure levels may cause permanent hearing loss. ZAPCO strongly advises that you use common sense when setting volume levels. Everything written in this manual is for the proper use of the products. Some features or specifications could be modified during production to improve the product performance. The technical specifications and functionalities stated here are current as of the time of publication. General instructions and safety warnings are intended in any case to be always effective for this type of product. The latest manual with any updates is always available at www.zapco.com/download



Modesto, California USA
Since 1974

zapco.com